

GCSE Mathematics Specification (8300/2F)

F

Paper 2 Foundation tier

Date

Morning

1 hour 30 minutes

Materials

For this paper you must have:

- a calculator
- mathematical instruments.



Instructions

- Use black ink or black ball-point pen. Draw diagrams in pencil.
- Fill in the boxes at the bottom of this page.
- Answer **all** questions.
- You must answer the questions in the spaces provided. Do not write outside the box around each page or on blank pages.
- Do all rough work in this book.
- In all calculations, show clearly how you work out your answer.

Information

- The marks for questions are shown in brackets.
- The maximum mark for this paper is 80.
- You may ask for more answer paper, graph paper and tracing paper. These must be tagged securely to this answer book.

Please write clearly, in block capitals, to allow character computer recognition.

Centre number

Candidate number

Surname

Forename(s)

Candidate signature _____

Answer **all** questions in the spaces provided.

1 Which of these numbers is **one more** than a multiple of 5?

Circle your answer.

[1 mark]

15

19

26

30

2 Which of these numbers has **exactly three** factors?

Circle your answer.

[1 mark]

3

4

5

6

3 Which of these numbers is **6 less** than -1.4 ?

Circle your answer.

[1 mark]

-8.4

-7.4

-2.0

4.6

- 4 Which shape is congruent to shape X?
Circle the correct letter.

[1 mark]

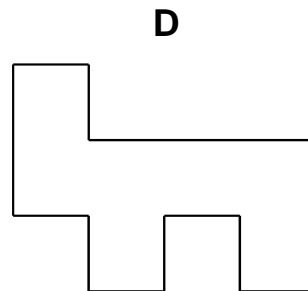
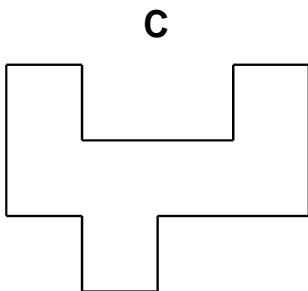
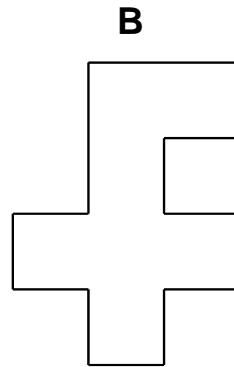
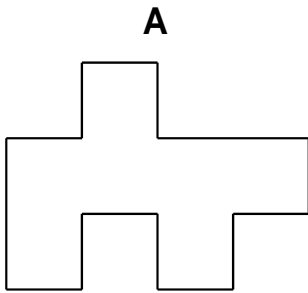
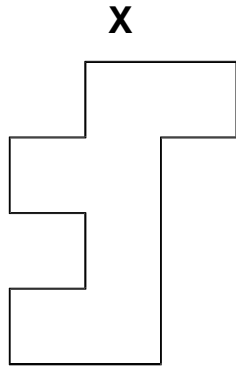

- 5 The map shows the positions of two ships, A and B.

Scale: 1 cm represents 2.5 km

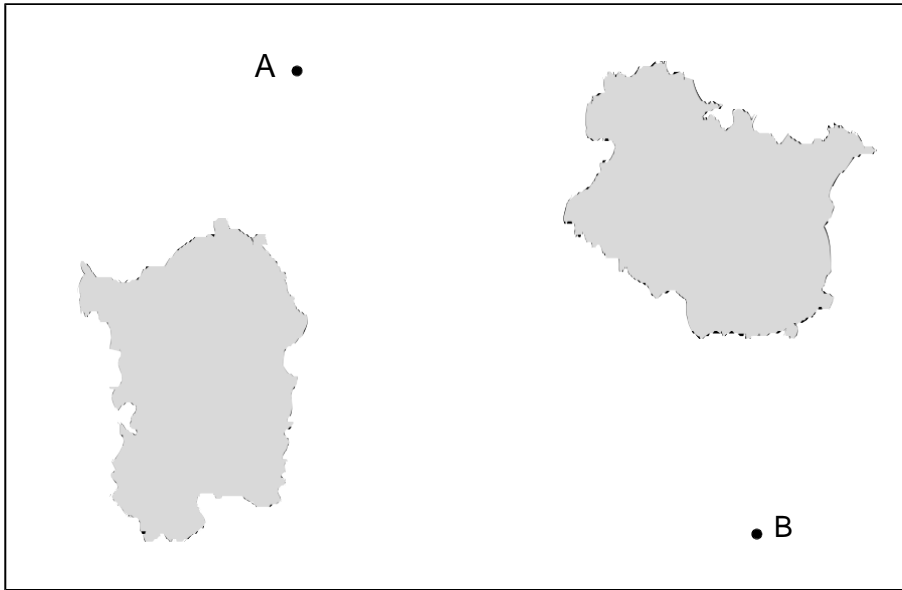

Work out the actual distance between the ships.

[2 marks]

Answer _____ km

6 A gym has 275 members.

40% are bronze members.

28% are silver members.

The rest are gold members.

Work out the number of gold members.

[3 marks]

Answer _____

Turn over for the next question

7 (a) Alan is looking at number machine problems.

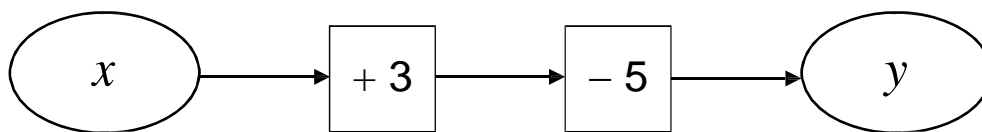

He says,

“If I know y I can work out x .
I subtract 3 then I add 5.”

Does this method work?

Give a reason for your answer.

[1 mark]

7 (b)

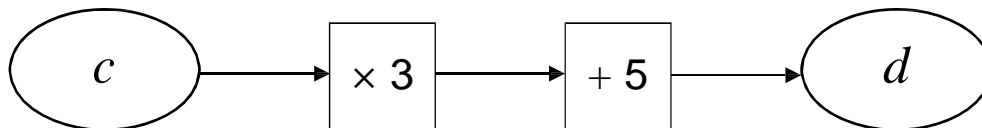

He says,

“If I know d I can work out c .
I divide by 3, then subtract 5.”

Does this method work?

Give a reason for your answer.

[1 mark]

8 (a) Solve $5w - 11 = 24$

[2 marks]

$w =$ _____

8 (b) Write an expression for the total cost, in pounds, of

x jumpers at £15 each
and
 y shirts at £12 each.

[1 mark]

Answer _____

8 (c) Simplify $x + x + y \times y$

[1 mark]

Answer _____

- 9** Lucy says,
"3 is odd and 2 is even,
so when you add a multiple of 3 to a multiple of 2 the answer is always odd."

Is she correct?

Write down a calculation to support your answer.

[1 mark]

- 10** Tom earns £9.20 per hour.

He works for

24 hours each week

48 weeks each year.

He pays tax if he earns more than £10 000 per year.

Does Tom pay tax?

You **must** show your working.

[2 marks]

- 11 Three boxes contain counters.

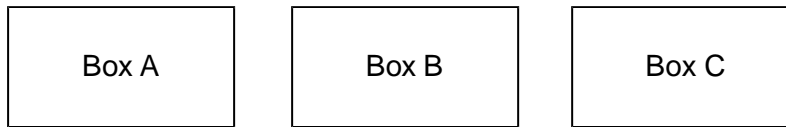

There are 62 counters in total.

The total number of counters in box A and box B is 34

The difference between the number of counters in box A and box C is 9

Work out the number of counters in each box.

[3 marks]

Box A _____ Box B _____ Box C _____

Turn over for the next question

- 12** The pie chart shows information about the sales of 800 tickets.
There were twice as many adult ticket sales as senior ticket sales.

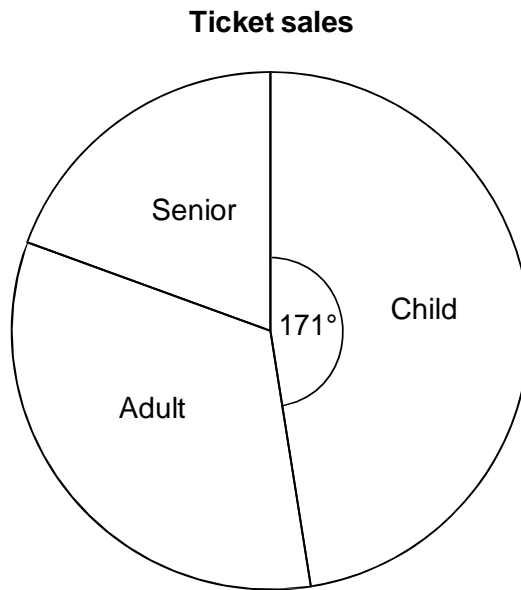

- 12 (a)** Show that there were 140 senior ticket sales.

[3 marks]

12 (b) Draw a bar chart on the grid to represent the child, adult and senior ticket sales.

[4 marks]

Ticket sales

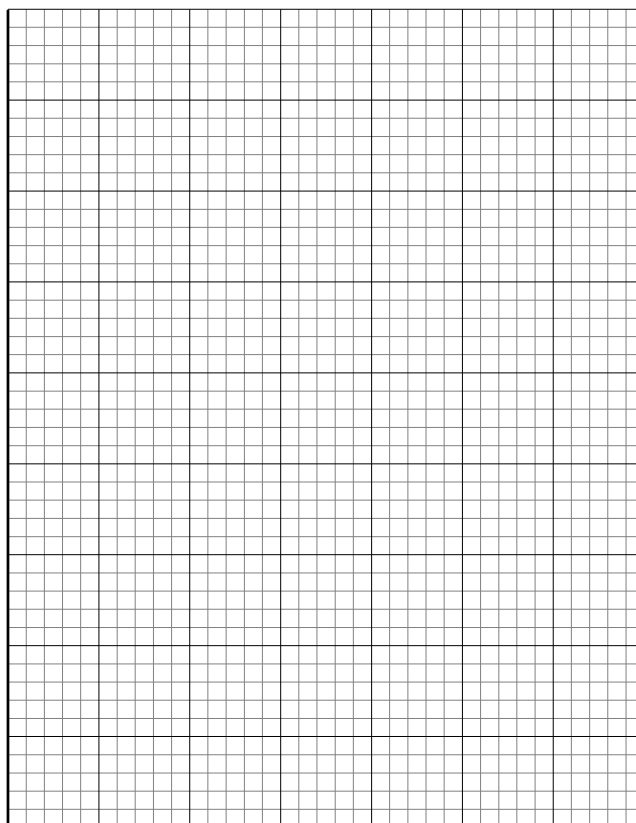

- 13** Alice makes cards.
Each card uses 42 cm of ribbon.
She has 1000 cm of ribbon.

13 (a) Work out the **maximum** number of cards she can make.

[2 marks]

Answer _____

13 (b) How much ribbon will be left over?

[1 mark]

Answer _____ cm

- 14** Luke saves 10p coins and 20p coins.
He has
 three times as many 10p coins as 20p coins
 a total of £17

How many 10p coins does he have?

[3 marks]

Answer _____

Turn over for the next question

- 15** A company has bikes for hire.
The cost, £ C , to hire a bike for n days is given by the formula

$$C = 12 + \frac{27}{4}(n - 1)$$

- 15 (a)** Write down the cost to hire a bike for 1 day.

[1 mark]

Answer £ _____

- 15 (b)**

<p style="text-align: center;">Special offer Hire a bike for £9 per day</p>
--

Is it cheaper to hire a bike for 7 days using the special offer?

You **must** show your working.

[2 marks]

15 (c) The graph shows the cost to hire a bike for one to five days at a different company.

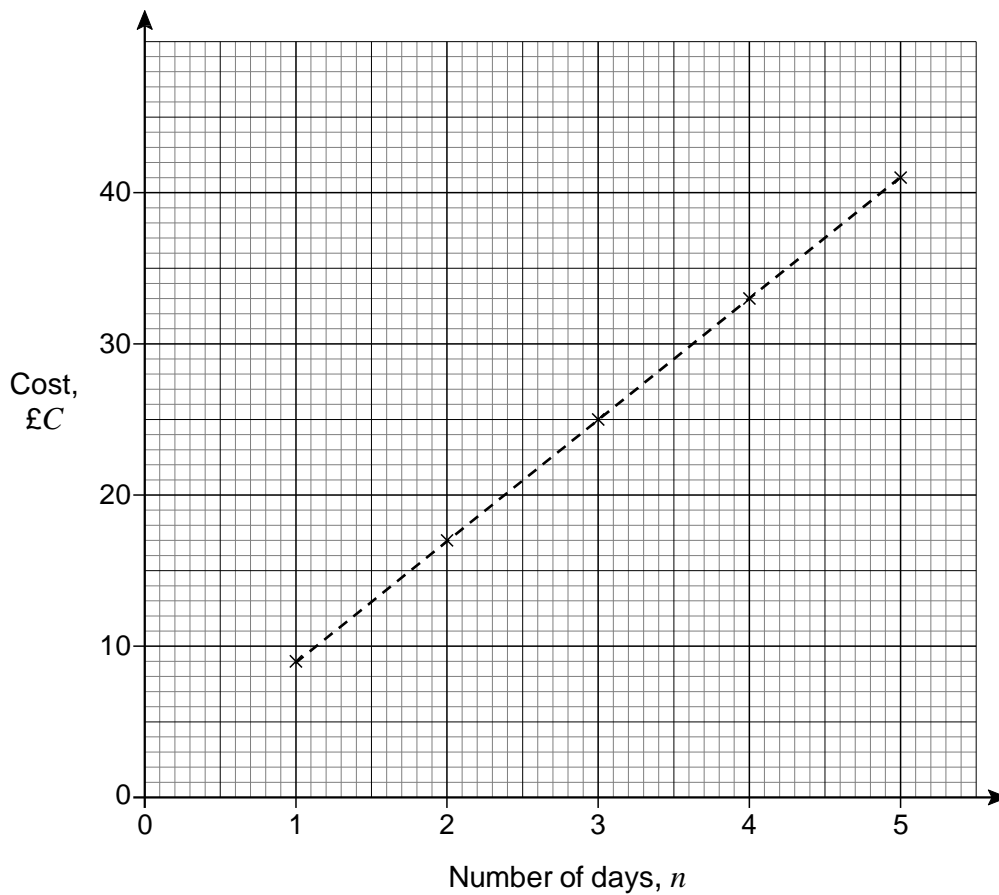

The cost, £ C , to hire a bike for n days using this company is given by the formula

$$C = a + b(n - 1)$$

Work out the values of a and b .

[3 marks]

$$a = \underline{\hspace{2cm}} \qquad b = \underline{\hspace{2cm}}$$

16 A company's logo

- is a pentagon
- has exactly one line of symmetry
- has sides with whole number lengths
- has a perimeter of 15 cm

Draw a sketch of a possible logo.

Label each side with its length.

[2 marks]

18 Here are two number machines, **A** and **B**.

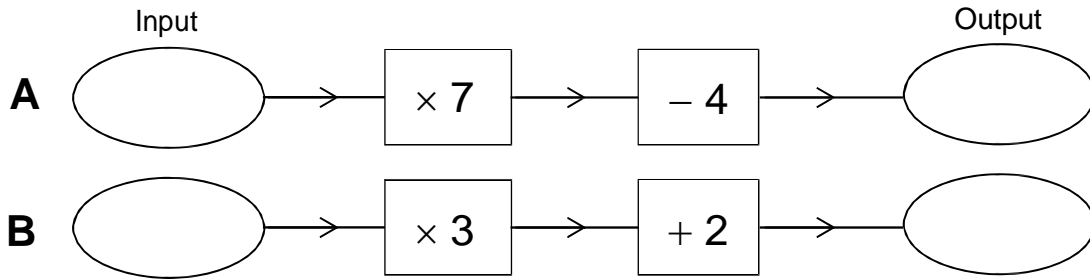

Both machines have the same input.

Work out the input that makes

the output of **A** three times the output of **B**.

[4 marks]

Answer _____

- 19** Josef runs 400 metres in 1 minute.
He assumes he can run any distance at the same rate.
He says,

“I would run 10 000 metres in 25 minutes.”

Tick a box to show whether his time to run 10 000 metres is likely to be accurate.

No, the time will be longer

Yes, the time will be 25 minutes

No, the time will be shorter

Give working and a reason to support your answer.

[2 marks]

- 20** Which sequence is a geometric progression?
Circle your answer.

[1 mark]

1 2 3 4

1 2 4 7

1 2 4 8

1 2 3 5

- 21 This pyramid has a square base.

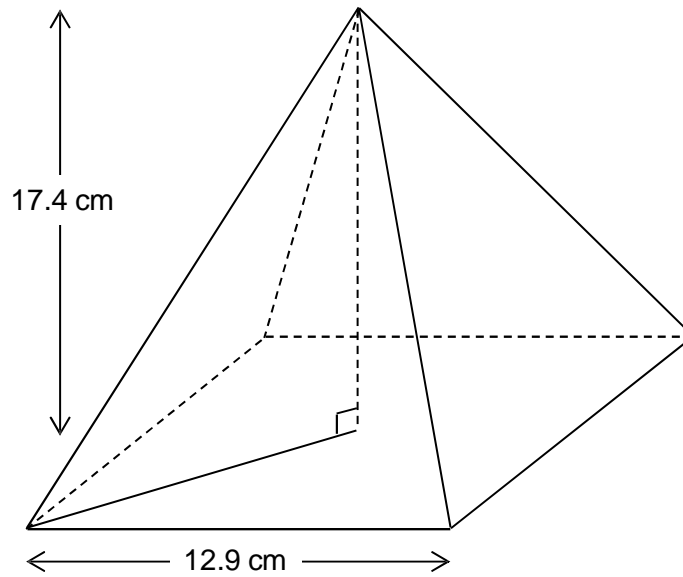

Volume of a pyramid = $\frac{1}{3}$ × area of base × perpendicular height

Work out the volume of the pyramid.

[3 marks]

Answer _____ cm^3

22 $\xi = \{1, 2, 3, 4, 5, 6, 7, 8, 9, 10, 11, 12\}$

S = square numbers

E = even numbers

22 (a) Complete the Venn diagram.

[3 marks]

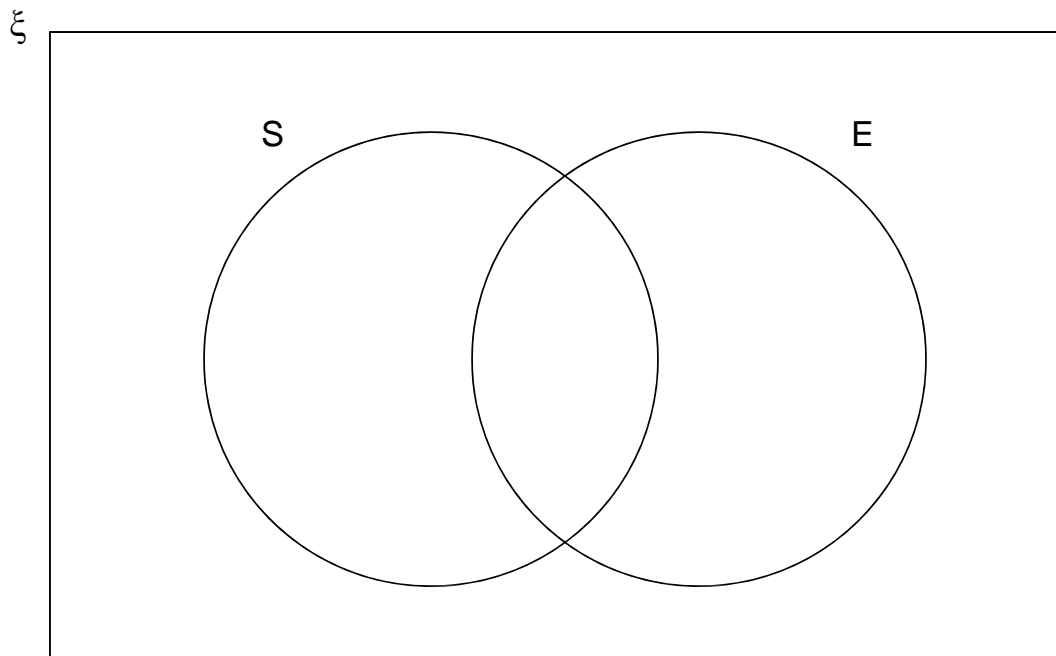

22 (b) One of the numbers is chosen at random.

Write down $P(S \cap E)$

[1 mark]

Answer _____

- 23** A coin is rolled onto a grid of squares.
It lands randomly on the grid.
To win, the coin must land completely within one of the squares.

Meera and John each roll the coin a number of times and record their results.

	Number of wins	Number of losses
Meera	6	44
John	28	72

- 23 (a)** Work out **two** different estimates for the probability of winning.

[2 marks]

Answer _____ and _____

- 23 (b)** Which of your estimates is the better estimate for the probability of winning?
Give a reason for your answer.

[1 mark]

Answer _____

Reason _____

24 In a sale, the original price of a bag was reduced by $\frac{1}{5}$

The sale price of the bag is £29.40

Work out the original price.

[3 marks]

Answer £ _____

25 Which of these is **not** used to prove that triangles are congruent?

Circle your answer.

[1 mark]

SSS

SAS

AAA

RHS

Turn over for the next question

- 26 E is the centre of rectangle $ABCD$.

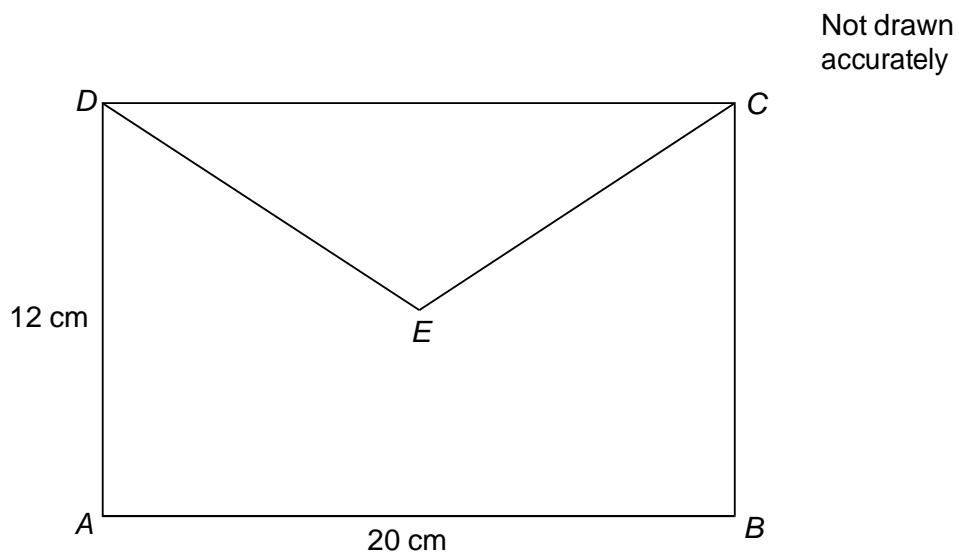

Work out the length DE .

[3 marks]

Answer _____ cm

- 27 Circle the equation of a line that is parallel to $y = 5x - 2$

[1 mark]

$$y = 2x - 5$$

$$y = 5x + 2$$

$$y = 3x - 2$$

$$y = -\frac{1}{5}x - 2$$

- 30** A pattern is made from two **similar** trapeziums.

Not drawn accurately

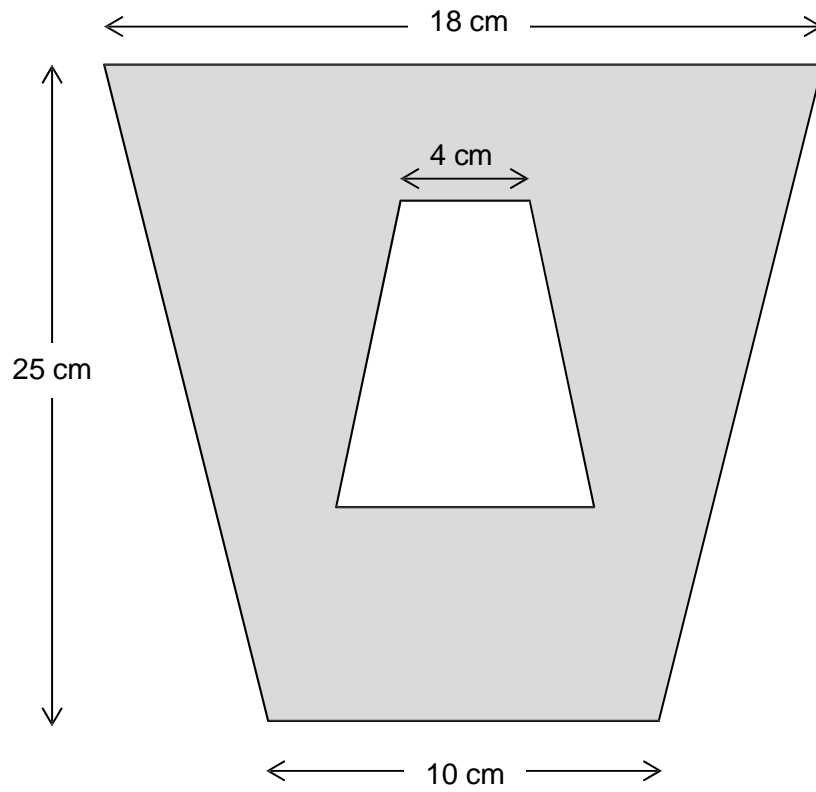

Show that the shaded area is 294 cm^2

[4 marks]

END OF QUESTIONS