

Wednesday 12 June 2019 – Morning

GCSE (9–1) Chemistry B (Twenty First Century Science)

J258/02 Depth in Chemistry (Foundation Tier)

Time allowed: 1 hour 45 minutes

You must have:

- a ruler (cm/mm)
- the Data Sheet (for GCSE Chemistry B (inserted))

You may use:

- a scientific or graphical calculator
- an HB pencil

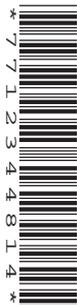

Please write clearly in black ink. **Do not write in the barcodes.**

Centre number

--	--	--	--	--

Candidate number

--	--	--	--

First name(s)

Last name

INSTRUCTIONS

- The Data Sheet will be found inside this document.
- Use black ink. You may use an HB pencil for graphs and diagrams.
- Answer **all** the questions.
- Where appropriate, your answers should be supported with working. Marks may be given for a correct method even if the answer is incorrect.
- Write your answer to each question in the space provided. If additional space is required, you should use the lined page(s) at the end of this booklet. The question number(s) must be clearly shown.

INFORMATION

- The total mark for this paper is **90**.
- The marks for each question are shown in brackets [].
- Quality of extended responses will be assessed in questions marked with an asterisk (*).
- This document consists of **28** pages.

Answer **all** the questions.

- 1 Ali does an experiment to find out how the pH changes when he adds dilute sodium hydroxide to dilute sulfuric acid.

He puts the dilute acid in a beaker and adds dilute sodium hydroxide, 1.0 cm^3 at a time.

He uses a pH meter to measure the pH of the mixture during the reaction, as shown in **Fig. 1.1**.

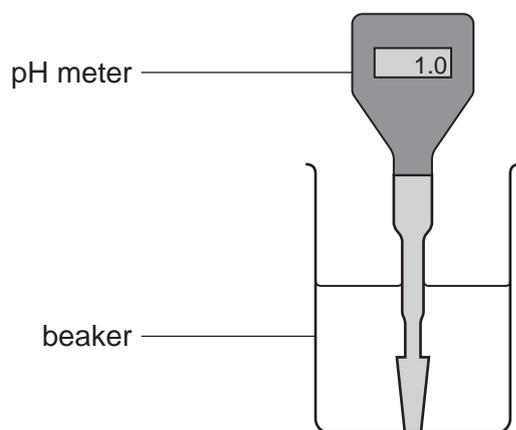

Fig. 1.1

Ali plots a graph of his results, as shown in **Fig. 1.2**.

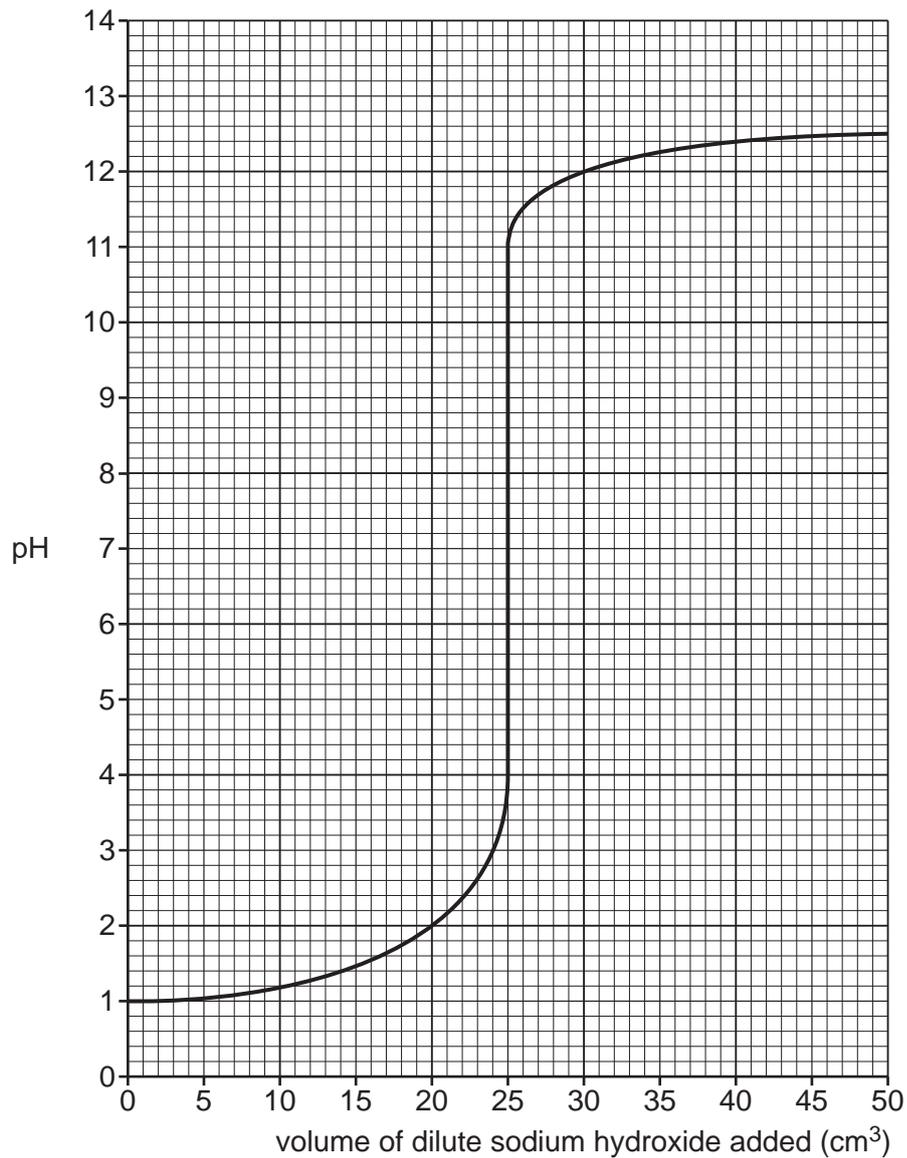

Fig. 1.2

- (a) (i) Use values from the graph in **Fig. 1.2** to describe how the pH changes when dilute sodium hydroxide is added to the acid.

.....

 [2]

- (ii) Explain why the pH readings at the start, and at the end of the reaction, are different.

.....

 [2]

(b) Ali writes an equation for the reaction.

(i) Balance the symbol equation by putting numbers on the dotted lines.

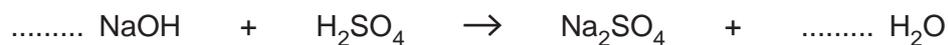

[1]

(ii) Draw lines to connect each **substance** with its correct **formula**.

Substance	Formula
water	NaOH
sodium sulfate	H ₂ SO ₄
sulfuric acid	Na ₂ SO ₄
sodium hydroxide	H ₂ O

[2]

(c) The reactions of acids with hydroxides can be shown by this general equation.

(i) Complete the word and symbols equations by filling.

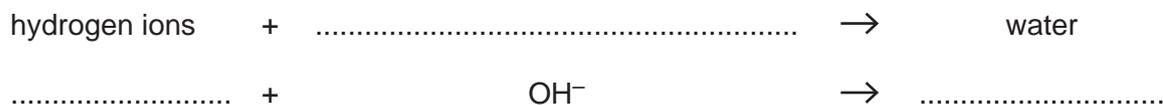

[2]

(ii) What is the name for this type of reaction?

Put a **ring** around the correct answer.

filtration **oxidation** **precipitation** **neutralisation**

[1]

2 Polymers are made when small monomer molecules react together.

The diagram shows a general formula for some monomers that react to make addition polymers.

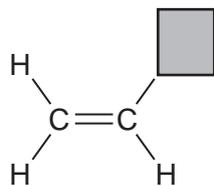

 represents an atom or group of atoms in the formula.

The table shows the formulae of some monomers.

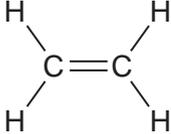
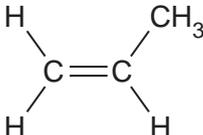
Name of polymer	Monomer	 represents
poly(ethene)		H
PVC	Cl
poly(propene)	

(a) Complete the table by filling in the missing information. [2]

(b) The structure of each polymer can be shown as a repeating unit.

Complete the diagram below by drawing the bonds in the **repeating unit** of poly(ethene).

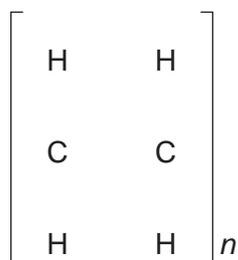

[2]

(c) The formula of the poly(propene) monomer can be shown as $\text{CH}_2\text{CH}(\text{CH}_3)$.

(i) Calculate the relative formula mass of the poly(propene) monomer.

Use the Periodic Table to help you.

Relative formula mass = [2]

(ii) The relative formula mass of an ethene monomer is 28.

A poly(ethene) polymer has an average relative formula mass of 11200.

How many ethene monomers have been joined to make this poly(ethene) polymer?

Number of ethene monomers = [1]

- 3 Malachite is an ore of copper that contains copper carbonate, CuCO_3 . It is mined on a large scale all over the world.

The flowchart in **Fig. 3.1** shows how copper can be made from copper carbonate, either in industry, or on a small scale in the laboratory.

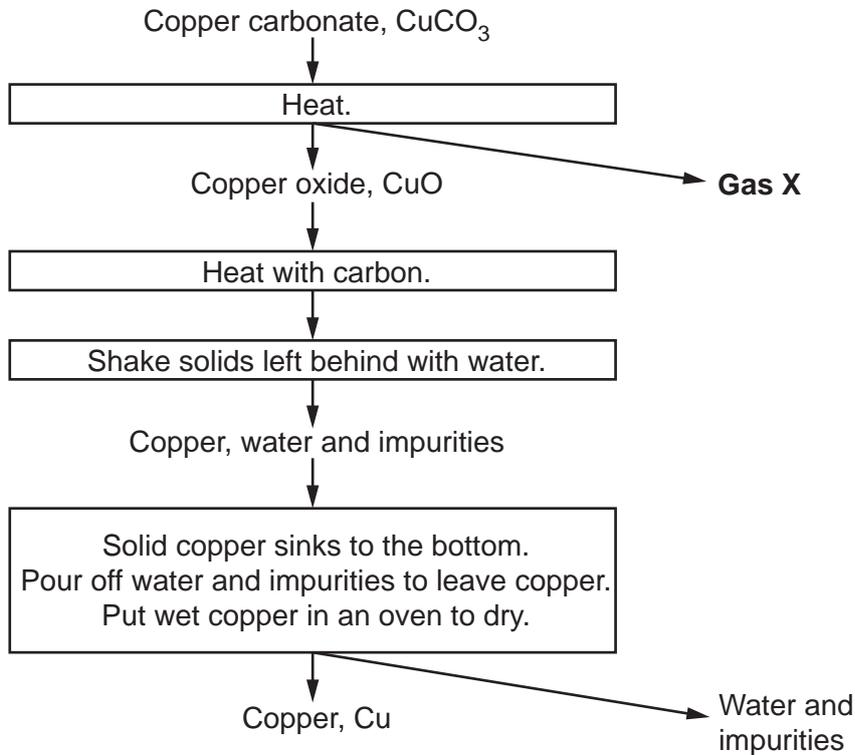

Fig. 3.1

- (a) **Gas X** forms when copper carbonate is heated.

What is the name of **gas X**?

Put a (ring) around the correct answer.

carbon dioxide **chlorine** **hydrogen** **nitrogen**

[1]

- (b) Which substances in **Fig. 3.1** are **raw materials**, which are **products** and which are **waste**?

Tick (✓) **one** box in each row.

Substance	Raw Material	Product	Waste
copper carbonate			
gas X			
carbon			
water and impurities			
copper			

[2]

(c) Jane uses the flowchart in **Fig. 3.1** as a method to make copper in the laboratory.

Jane's teacher gives her **Fig. 3.2** to help her predict the theoretical yield of copper.

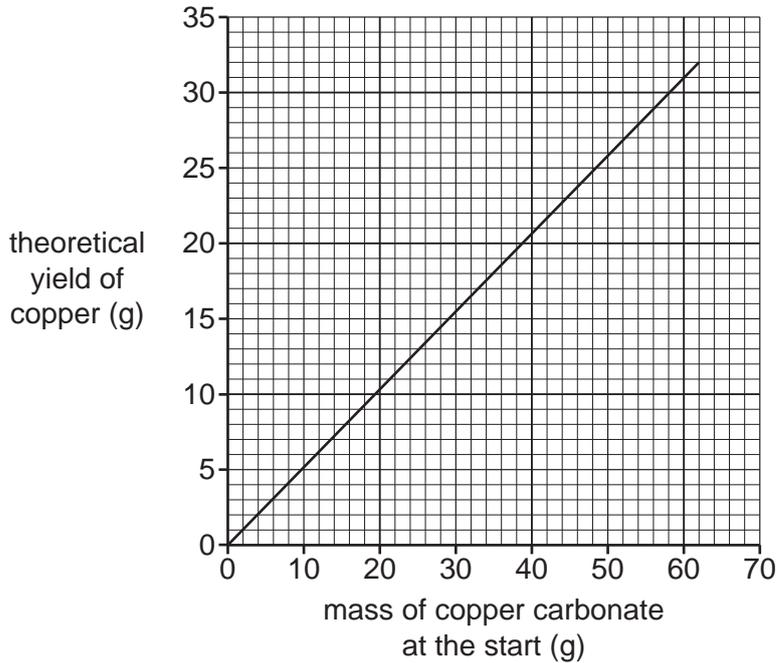

Fig. 3.2

(i) Jane looks at **Fig. 3.2** and thinks that the theoretical yield of copper is directly proportional to the mass of copper carbonate at the start.

Use values from the graph in **Fig. 3.2** to explain why Jane is right.

.....

 [2]

(ii) Explain why the line on the graph in **Fig. 3.2** starts at 0 on both axes.

.....
 [1]

(iii) Jane wants to make a theoretical yield of 15.0g of copper.

What starting mass of copper carbonate should she use?

Use the graph in **Fig. 3.2** to help you.

Mass of copper carbonate = g [1]

- (iv) Jane does the experiment. She measures the mass of copper she makes (her actual yield).

The mass of copper she makes is higher than she predicts. She knows that she has made mistakes.

Which two mistakes could lead to an incorrectly high yield?

Tick (✓) **two** boxes.

She did not use enough copper carbonate.

She did not dry the copper at the end.

She did not heat the copper oxide for long enough.

Her copper contains solid impurities.

[2]

(d) Nina and Kai also follow the flowchart in **Fig. 3.1** to make some copper.

They compare the mass of copper they make at the end (their actual yield) with each other.

Name	Mass of copper carbonate at the start (g)	Theoretical yield of copper (g)	Mass of copper made (actual yield) (g)
Nina	50.0	26.0	18.0
Kai	10.0	5.0	4.8

They make statements about their results.



Nina
I have made much more copper than you.

Kai
Yes, but my percentage yield of copper is higher than yours.



Are Nina and Kai's statements correct?

Use data from the table to explain your answers.

Nina

.....

.....

Kai

.....

..... [2]

4 Eve does an experiment to find out if chlorine is more reactive than iodine.

She adds a few drops of chlorine water to aqueous potassium iodide.

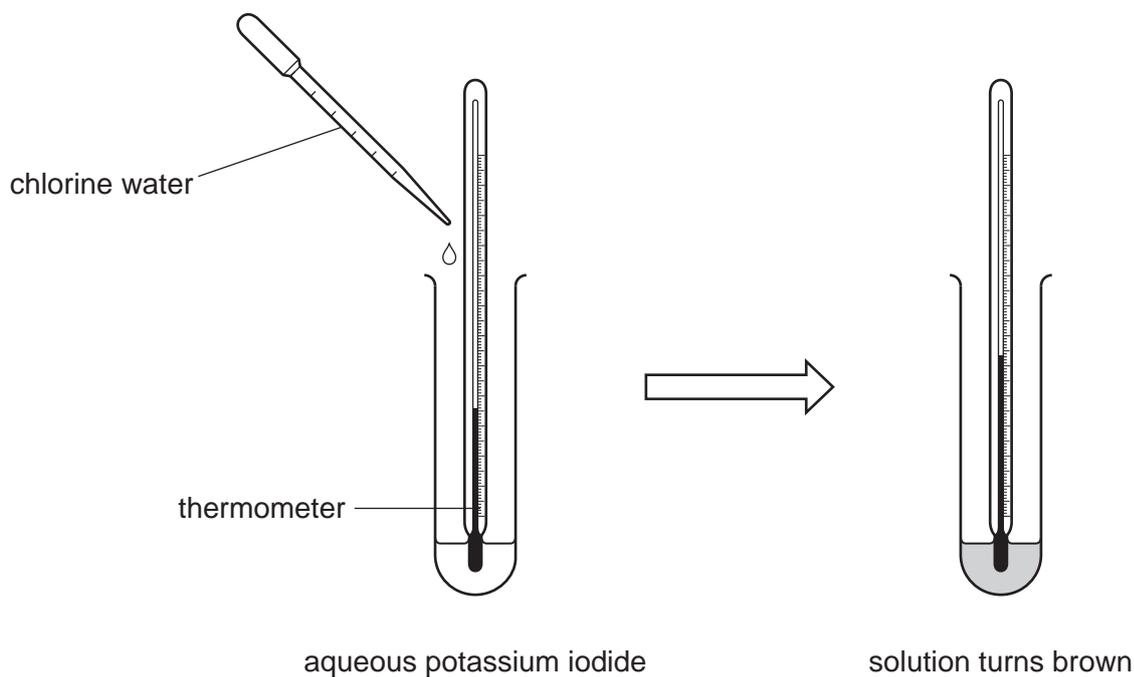

The solution turns brown and there is an increase in temperature.

She writes this equation for the reaction.



(a) Add the missing **state symbols** to the equation. [1]

(b) Write a **word** equation for this reaction.

..... [1]

(c) Explain why the solution turns brown.

..... [1]

(d) Complete the sentences about this reaction by putting a **ring** around **one** word in each line.

The temperature increase shows that the reaction is **endothermic** / **exothermic**.

The reaction happens because chlorine is **more** / **less** reactive than iodine.

This type of reaction is called **displacement** / **precipitation**.

The reaction makes iodine and a **metal** / **salt**.

[3]

Turn over

5 **Table 5.1** shows the melting points of some transition metals.

Metal	Melting point (°C)
mercury	-39
vanadium	1910
copper	1100
chromium	1900
zinc	420

Table 5.1

(a) Complete each sentence.

Use the symbols.

You can use each symbol once, more than once, or not at all.

=

<

~

>

The melting point of mercury

the melting point of vanadium.

The melting point of vanadium

the melting point of chromium.

The melting point of chromium

the melting point of zinc.

[2]

(b) The **boiling** point of mercury is 357 °C. Room temperature is 20 °C.

(i) What is the **state** of mercury at room temperature?

Put a **ring** around the correct answer.

aqueous solution

gas

liquid

solid

[1]

(ii) Explain the reasoning for your answer to (b)(i).

.....
 [2]

(c) Table 5.2 shows more information about **copper**, **zinc** and **mercury**.

Metal	Colour of metal oxide	Acts as a catalyst
copper	black or red	yes
zinc	white	no
mercury	red	yes

Table 5.2

Zinc is **not** a typical transition metal.

Which two statements show that it is **not** a typical transition metal?

Tick (✓) **two** boxes.

All transition metals have red oxides.

Transition metals are good catalysts.

Zinc does not form coloured compounds.

Zinc is in Group 1.

[2]

- 6 Ammonium sulfate is a fertiliser. It is usually sold to farmers as a solid in large sacks.

Different industrial processes can be used to make ammonium sulfate.

Process	Equation	How the process works	Other points
1	$2\text{NH}_3 + \text{H}_2\text{SO}_4 \rightarrow (\text{NH}_4)_2\text{SO}_4$	Reactor kept at 60 °C. Uses concentrated sulfuric acid. A solution of ammonium sulfate is made.	Reaction is exothermic. Atom economy 100%.
2	$2\text{NH}_3 + \text{H}_2\text{SO}_4 \rightarrow (\text{NH}_4)_2\text{SO}_4$	Sulfuric acid is sprayed into dry ammonia gas. Dry powdered ammonium sulfate is made.	Reaction is exothermic. Atom economy 100%.
3	$(\text{NH}_4)_2\text{CO}_3 + \text{CaSO}_4 \rightarrow (\text{NH}_4)_2\text{SO}_4 + \text{CaCO}_3$	Calcium carbonate forms as a precipitate in a solution of ammonium sulfate.	Atom economy 57%. Calcium carbonate is a waste product.

Use information from the table to answer these questions.

- (a) In **process 1**, the reactor reaches 60 °C without being heated.

Explain why the reactor keeps hot **without** being heated.

.....
..... [2]

- (b) Suggest **one** advantage of using **process 2** to make ammonium sulfate, rather than the other two processes.

.....
..... [2]

- (c) Use the equations in the table to explain why the atom economies of the processes are different.

.....

.....

.....

..... [2]

- (d) (i) The method used in **process 3** can also be done in the laboratory.

Which two techniques are needed to separate solid ammonium sulfate from the final reaction mixture?

Tick (✓) **two** boxes.

Filtration

Distillation

Neutralisation

Evaporation

[2]

- (ii) Ammonium sulfate is made in the laboratory in a **batch** process.

The processes that make ammonium sulfate in industry are **continuous** processes.

Describe the **differences** between batch and continuous processes.

.....

.....

.....

..... [2]

8 Over the last 20 years, there have been a series of agreements between governments to limit the emission of greenhouse gases. These gases include carbon dioxide, methane and nitrous oxides.

(a) **Table 8.1** shows some measurements of the concentrations of these gases in the atmosphere now.

Gas	Concentration in the atmosphere
carbon dioxide	0.04%
methane	1800 ppb
nitrous oxides	1400 ppb

Table 8.1

The units used to measure the concentration of the gases are different.

(i) Calculate the concentration of carbon dioxide, in ppb.

1% = 10 000 000 ppb (parts per billion)

Concentration = ppb **[2]**

(ii) Governments think that reducing emissions of carbon dioxide will have a bigger effect on the environment, than reducing emissions of the other gases.

Use the data in **Table 8.1** to explain why they are right.

.....

 **[2]**

(b) The first major agreement between countries was the 1997 Kyoto Protocol.

The graph in **Fig. 8.1** shows the concentration of some greenhouse gases in the atmosphere before the Kyoto Protocol was introduced.

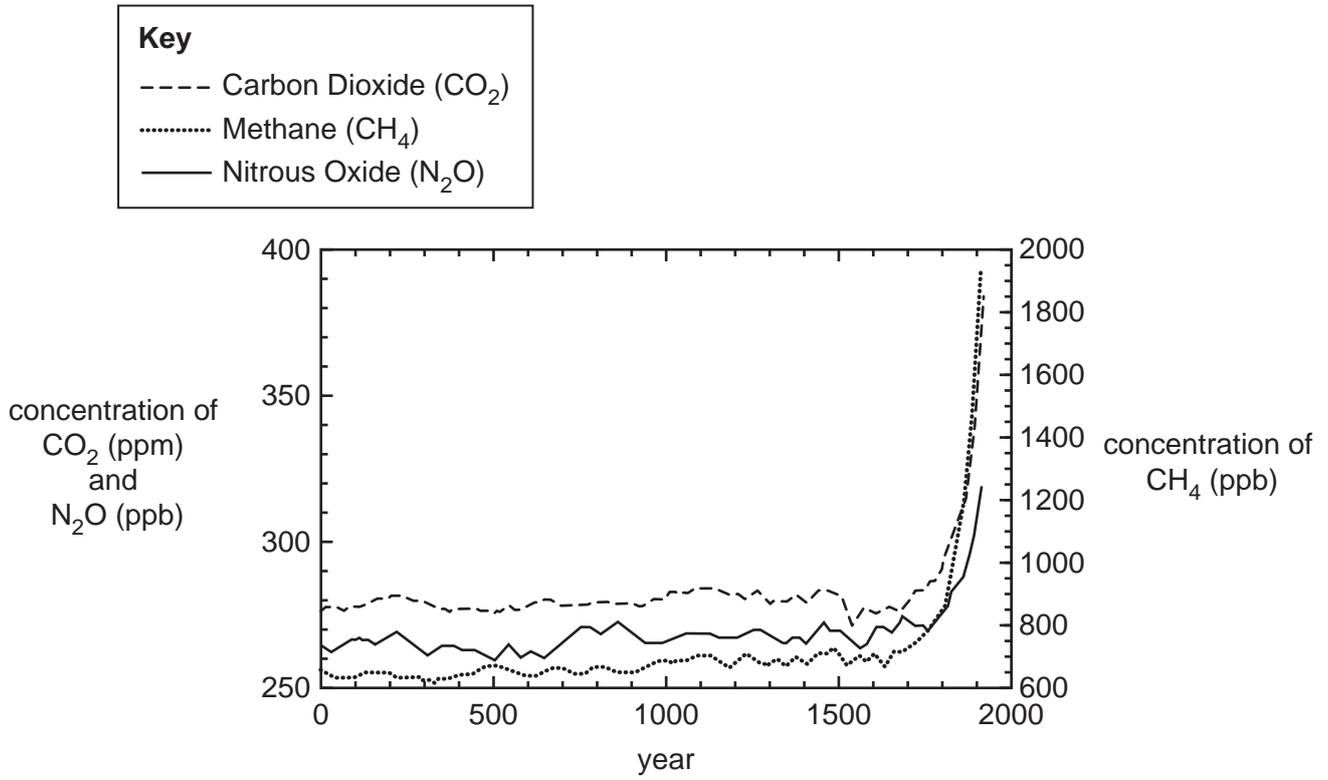

Fig. 8.1

(i) Which statements about the data in **Fig. 8.1** are **true** and which are **false**?

Tick (✓) **one** box in each row.

Statement	True	False
For each gas the concentration remained approximately constant for 1500 years.		
The concentration of methane is usually higher than the concentration of nitrous oxide.		
The concentration of carbon dioxide is measured in ppb.		
The concentration of all three gases has more than doubled since 1500 years ago.		

[3]

(ii) Amir makes this comment about the graph.

Amir

There are general correlations on the graph but annual concentrations do not show close correlations.



Do you agree with Amir?

Yes

No

Use the graph in **Fig. 8.1** to explain your answer.

.....

.....

..... [2]

20
BLANK PAGE

PLEASE DO NOT WRITE ON THIS PAGE

10 Alex collects some samples of minerals from a spoil heap near an old mine.

Alex tests two samples of minerals, **A** and **B**, to identify the ions that they contain.

(a) He carries out flame tests on each sample and compares his results (**Table 10.1**) to a reference book of flame colours for some metal ions (**Table 10.2**).

Alex's results

Mineral	Flame colour
A	green
B	orange-red

Table 10.1

Reference book

Metal ion	Flame colour
copper	blue-green
calcium	orange-red
iron	varies with temperature blue/green/yellow/orange
zinc	green

Table 10.2

Use information from **Table 10.1** and **Table 10.2** to explain why Alex cannot be certain which ions are in the samples.

.....

.....

.....

..... [3]

(b) Alex makes a solution of a sample of each mineral in water and does some further tests.

The tests he carries out, and his results, are shown in **Table 10.3**.

Mineral	Test	Result
A	Add dilute sodium hydroxide.	blue precipitate
	Add dilute hydrochloric acid.	fizzes, gas given off turns lime water milky
	Add dilute silver nitrate.	white precipitate
B	Add dilute sodium hydroxide.	white precipitate does not dissolve in excess
	Add dilute hydrochloric acid.	no change
	Add dilute silver nitrate.	white precipitate

Table 10.3

- (i) Alex thinks that mineral **A** contains two negative ions.

How can you tell from the results that Alex is right?

.....
 [1]

- (ii) Identify the ions in mineral **A** and mineral **B**.

Choose words from this list.

copper calcium iron zinc carbonate chloride sulfate

Ions in mineral A	Ions in mineral B
.....
.....
.....

[3]

- (c) Alex also has an emission spectroscopy machine to analyse samples of minerals.

Give **one** advantage of using an emission spectroscopy machine, rather than flame tests or chemical tests, to identify samples.

.....
 [1]

- 11 Silver nanoparticles are used in some socks to remove the smell of sweaty feet.



Silver nanoparticles have different properties to larger pieces of silver because they have a different surface area to volume ratio.

- (a) The diagram shows what happens when a larger cube of silver is cut into eight smaller cubes.

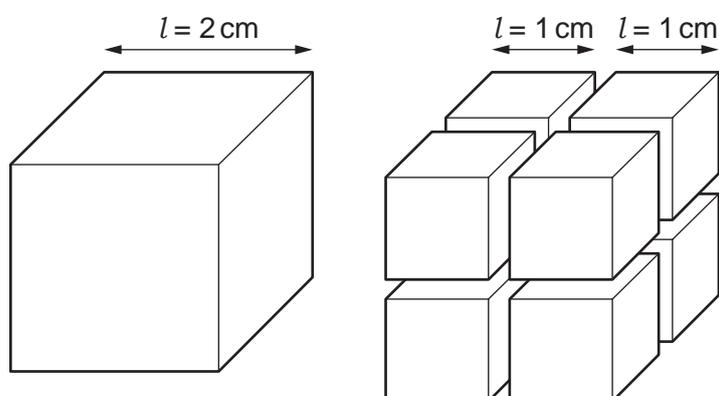

The volume and surface area of a cube can be worked out using these formulae:

$$\text{volume} = l \times l \times l$$

$$\text{surface area} = 6 \times l \times l$$

Table 11.1 shows the volume, surface area, and surface area to volume ratio for the larger cube.

Property	Larger cube	Smaller cubes
Total volume (cm ³)	8
Total surface area (cm ²)	24
Surface area to volume ratio (per cm)	3

Table 11.1

(i) Complete **Table 11.1** by filling in the blank spaces for the eight smaller cubes.

Use this space to show your working.

[3]

(ii) Use ideas about surface area and volume to explain why nanoparticles of silver have a different surface area to volume ratio than larger silver particles.

.....
.....
..... [2]

(b) New research has shown that nanoparticles may be used to treat cancer. However, some scientists are worried about the negative effects of nanoparticles on the body.

We are worried that metal nanoparticles may go through the natural holes in membranes into the brain where they might cause damage. Metal particles cannot usually go through the natural holes in membranes.



(i) Explain why metal nanoparticles may be able to enter the brain even though metal particles usually cannot.

.....
.....
.....
..... [2]

(ii) Use ideas about **risk** and **benefit** to evaluate the use of nanoparticles in socks and to treat cancer.

.....
.....
.....
.....
.....
..... [3]

ADDITIONAL ANSWER SPACE

If additional space is required, you should use the following lined page(s). The question number(s) must be clearly shown in the margin(s).

A large area of lined paper for writing. It features a vertical solid line on the left side, creating a margin. The rest of the page is filled with horizontal dotted lines, providing space for writing answers.

A large area of the page is reserved for writing, featuring a vertical solid line on the left side and horizontal dotted lines extending across the page.



Copyright Information

OCR is committed to seeking permission to reproduce all third-party content that it uses in its assessment materials. OCR has attempted to identify and contact all copyright holders whose work is used in this paper. To avoid the issue of disclosure of answer-related information to candidates, all copyright acknowledgements are reproduced in the OCR Copyright Acknowledgements Booklet. This is produced for each series of examinations and is freely available to download from our public website (www.ocr.org.uk) after the live examination series.

If OCR has unwittingly failed to correctly acknowledge or clear any third-party content in this assessment material, OCR will be happy to correct its mistake at the earliest possible opportunity.

For queries or further information please contact The OCR Copyright Team, The Triangle Building, Shaftesbury Road, Cambridge CB2 8EA.

OCR is part of the Cambridge Assessment Group; Cambridge Assessment is the brand name of University of Cambridge Local Examinations Syndicate (UCLES), which is itself a department of the University of Cambridge.