

OCR

Oxford Cambridge and RSA

GCSE (9–1) Chemistry A (Gateway Science)**J248/01 Paper 1 (Foundation Tier)**

Sample Question Paper

F**Date – Morning/Afternoon**

Time allowed: 1 hour 45 minutes

You must have:

- the Data Sheet

You may use:

- a scientific or graphical calculator
- a ruler



First name

Last name

Centre
numberCandidate
number**INSTRUCTIONS**

- Use black ink. You may use an HB pencil for graphs and diagrams.
- Complete the boxes above with your name, centre number and candidate number.
- Answer **all** the questions.
- Write your answer to each question in the space provided.
- Additional paper may be used if required but you must clearly show your candidate number, centre number and question number(s).
- Do **not** write in the bar codes.

INFORMATION

- The total mark for this paper is **90**.
- The marks for each question are shown in brackets [].
- Quality of extended response will be assessed in questions marked with an asterisk (*).
- This document consists of **28** pages.

SECTION A

Answer **all** the questions.

You should spend a maximum of 30 minutes on this section.

1 Which technique is the best for separating pure water from a solution of sodium chloride in water?

- A crystallisation
- B chromatography
- C filtration
- D distillation

Your answer

[1]

2 Lead is a metal.

Which statement is true about lead **because** it is a metal?

- A It is a dull grey colour.
- B It is in Group 4 of the Periodic Table.
- C It is in Period 6 of the Periodic Table.
- D It is malleable so can be easily shaped.

Your answer

[1]

3 When 12 g of carbon, C, burns in oxygen, O₂, 44 g of carbon dioxide, CO₂, is formed.

What mass of C would need to burn to form 11 g of CO₂?

- A 3 g
- B 4 g
- C 11 g
- D 12 g

Your answer

[1]

4 What is the relative formula mass of sodium carbonate, Na_2CO_3 ?

- A 83.0
- B 90.0
- C 106.0
- D 130.0

Your answer

[1]

5 The size of a nanoparticle is similar to the size of a molecule.

Which of these best describes the size of a nanoparticle?

- A 0.01 nm
- B 50 nm
- C 1000 nm
- D 10,000 nm

Your answer

[1]

6 Two isotopes of neon are:

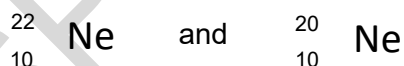

Isotopes have different:

- A numbers of protons
- B numbers of neutrons
- C charges
- D numbers of electrons

Your answer

[1]

- 7 The bar chart shows some information about the melting points of Group 1 elements.

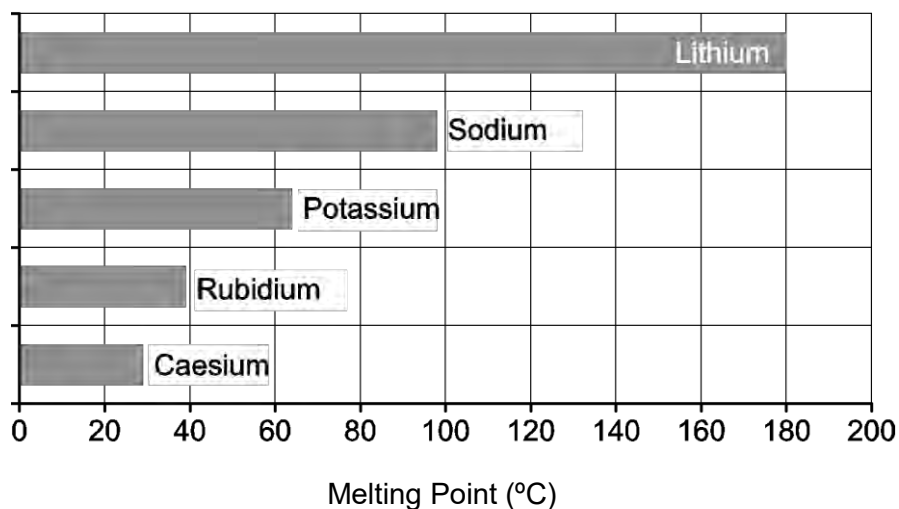

What are the melting points of rubidium and caesium?

	Melting point of rubidium (°C)	Melting point of caesium (°C)
A	39	29
B	40	25
C	29	41
D	41	25

Your answer

[1]

- 8 Tim is separating the colours in a sample of black ink using paper chromatography.

He puts a spot of black ink onto filter paper.

He dips the filter paper into ethanol in a beaker.

What is the name given to **ethanol** in this experiment?

- A** gas phase
- B** mobile phase
- C** solid phase
- D** stationary phase

Your answer

[1]

- 9 Look at Tim's chromatogram.

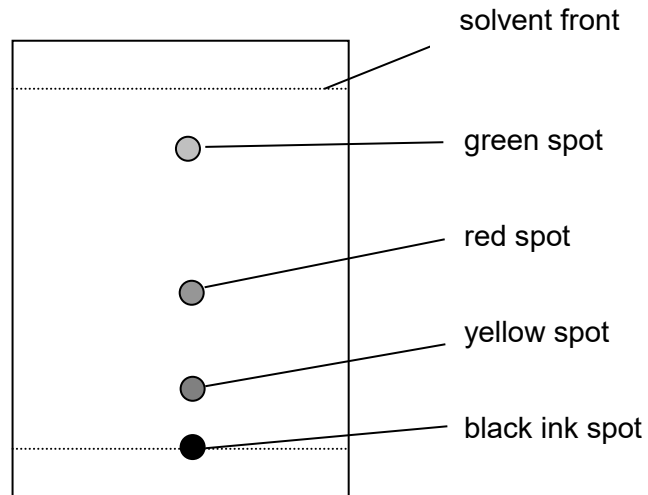

What is the R_f value of the **green spot**? Use a ruler to help you.

- A** 0.17
B 0.42
C 0.83
D 1.00

Your answer

[1]

- 10 What is the best description of the particles in a liquid?

	Distance between particles	Movement of particles
A	close together	in continuous random motion
B	close together	vibrating about a fixed point
C	far apart	in continuous random motion
D	far apart	vibrating about a fixed point

Your answer

[1]

11 Look at the table.

It shows some fractions made from the fractional distillation of crude oil and their boiling ranges.

Fraction	Boiling range (°C)
LPG	less than 25
petrol	85 – 105
diesel	150 – 290
fuel oil	290 – 380
bitumen	greater than 400

A hydrocarbon called eicosane has a boiling point which is 3.5 times the boiling point of petrol.

To which fraction does eicosane belong?

- A diesel
- B LPG
- C fuel oil
- D bitumen

Your answer

[1]

12 Look at the reaction profile for the reaction between hydrogen and chlorine.

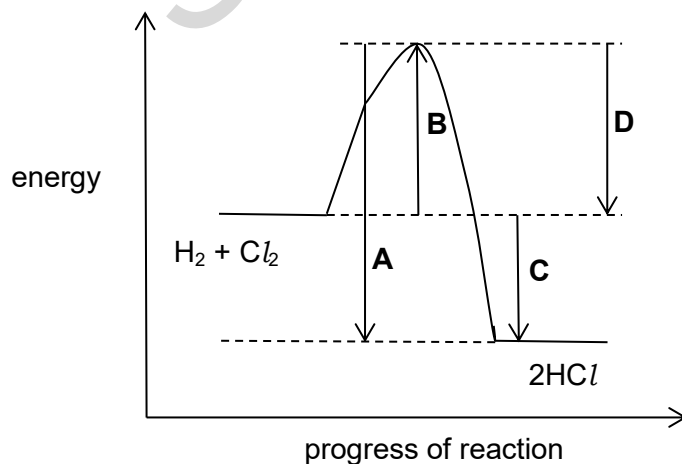
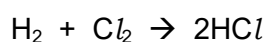

Which energy change represents the enthalpy change of reaction?

Your answer

[1]

13 The **molecular formula** of decene is $C_{10}H_{20}$.

What is the **empirical formula** of decene?

- A CH_2
- B C_2H_4
- C C_5H_{10}
- D $C_{20}H_{40}$

Your answer

[1]

14 Hardeep adds magnesium metal to a sample of acid and to a sample of alkali.

He measures the pH of the acid and the alkali.

What results should Hardeep expect?

	Result for acid experiment	Result for alkali experiment
A	pH below 7 no reaction with magnesium	pH above 7 magnesium fizzes
B	pH below 7 magnesium fizzes	pH above 7 no reaction with magnesium
C	pH above 7 magnesium fizzes	pH above 7 no reaction with magnesium
D	pH above 7 no reaction with magnesium	pH below 7 magnesium fizzes

Your answer

[1]

15 Rosa tests some compounds to find out if they conduct electricity.

Which row in the table shows the correct results for each compound?

	Solid ionic compound	Ionic compound dissolved in water	Molten ionic compound
A	conducts	does not conduct	conducts
B	conducts	conducts	conducts
C	conducts	conducts	does not conduct
D	does not conduct	conducts	conducts

Your answer

[1]

SPECIMEN

BLANK PAGE

PLEASE TURN OVER FOR THE NEXT QUESTION

SPECIMEN

(b) Look at how Phil does the experiment.

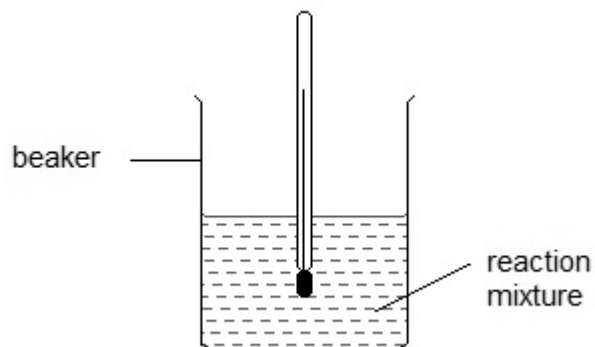

1. He measures the temperature of one of the reactants at the start.
2. He then adds the second reactant and stirs the mixture.
3. He removes the thermometer from the beaker and then reads it to take the temperature at the end of the reaction.

How should Phil improve his method? Explain your answer.

.....

.....

.....

..... [2]

(c) When Phil adds water to calcium oxide, a vigorous exothermic reaction takes place forming calcium hydroxide.

Calcium hydroxide has the formula $\text{Ca}(\text{OH})_2$.

Show that the relative formula mass, M_r , of calcium hydroxide is 74.1.

[2]

17 (a) Look at the diagram.

It shows the apparatus used for the electrolysis of some molten compounds.

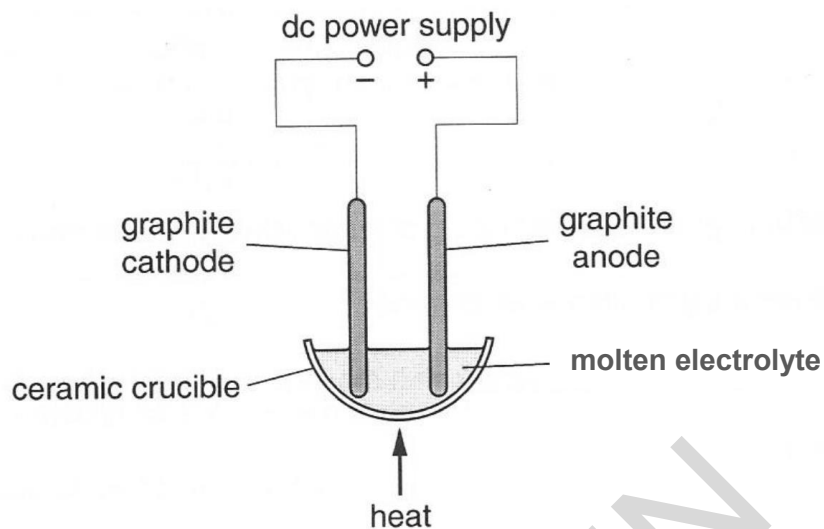

The table shows what is made at each electrode during the electrolysis of some molten compounds.

Molten electrolyte	Formula	Product at negative electrode (cathode)	Product at positive electrode (anode)
sodium chloride	NaCl	chlorine
lead bromide	PbBr_2	lead

Complete the table.

[2]

(b) Copper sulfate solution can be electrolysed using non-inert copper electrodes.

Describe what happens at the negative copper electrode **and** the positive copper electrode.

.....

..... [2]

- (c) Javier is electrolysing a solution of sodium chloride, NaCl , in water, H_2O .

Complete the list of ions present in sodium chloride solution.

Positive ions (cations)	Negative ions (anions)
Na^+
.....	OH^-

- (d) Here is a diagram of a sodium chloride crystal.

[2]

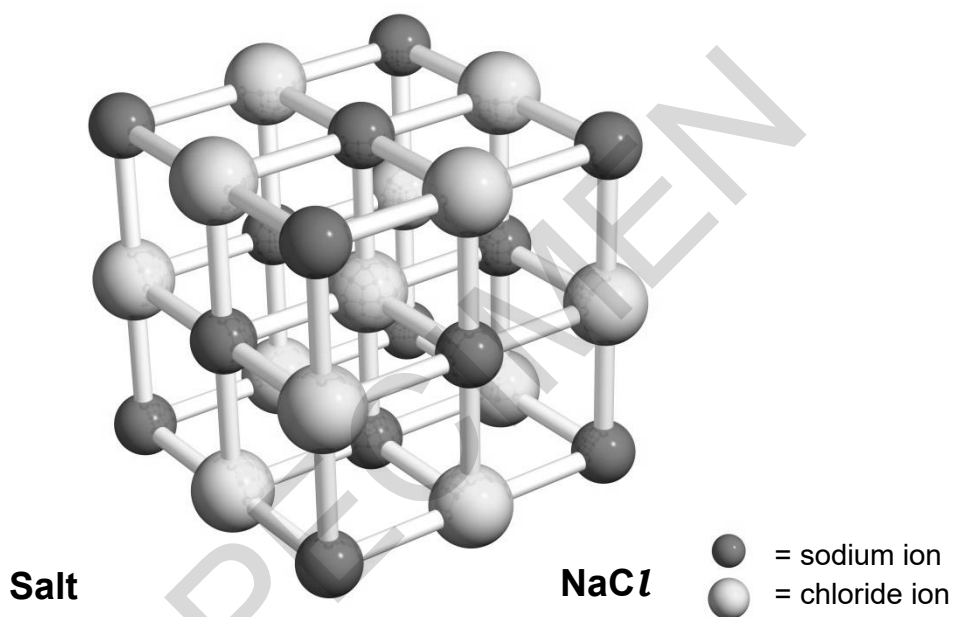

The Cl-Na-Cl length in a crystal of sodium chloride is 0.564 nm.

What is the volume of this cube in nm^3 ? Give your answer to 3 significant figures.

volume = nm^3

[3]

19 Magnesium burns in oxygen to make magnesium oxide.

The reaction involves both oxidation and reduction.

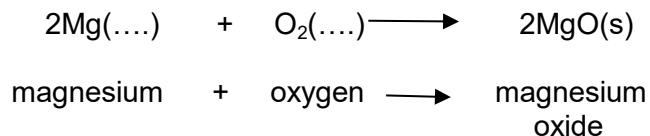

(a) Complete the equation above by adding the state symbols for magnesium and oxygen at room temperature.

[2]

(b) Which element is oxidised and which element is reduced?

oxidised:

reduced:

[1]

(c) Magnesium oxide reacts with water to make an alkaline solution.

Describe how you would measure the pH of the magnesium hydroxide solution.

A pH meter is **not** available.

.....

.....

.....

.....

[3]

- (b) (i) Zinc nitrate, $\text{Zn}(\text{NO}_3)_2$, can be made by reacting zinc oxide, ZnO , with nitric acid, HNO_3 .

Water, H_2O , is also made.

Write a **balanced symbol** equation for this reaction.

..... [2]

- (ii) Paul suggests this method for preparing zinc nitrate.

- | |
|--|
| <ol style="list-style-type: none">1. Measure 50cm^3 of dilute nitric acid into a beaker.2. Add 1 spatulaful of zinc oxide.3. Heat the mixture until crystals of zinc nitrate are made. |
|--|

Paul's method will not make a pure dry sample of zinc nitrate.

What improvements should Paul make to the method to make sure that:

- the reaction is complete
- the zinc nitrate can be separated from the nitric acid and the zinc oxide?

Explain your answer.

.....
.....
.....
.....
.....
.....
..... [4]

21 Look at the data about some hydrocarbons.

Name	Number of carbon atoms in molecule	Molecular formula	Boiling point (°C)
ethane	2	C ₂ H ₆	-88
propane	3	C ₃ H ₈	-42
pentane	5	C ₅ H ₁₂	36
hexane	6	C ₆ H ₁₄	69

(a) Butane contains 4 carbon atoms.

Use the table to suggest the molecular formula of butane.

.....

[1]

SPECIMEN

(b) The data for ethane and propane have been plotted on the grid.

(i) Plot the data for pentane and hexane on the grid.

Draw the line of best fit.

[2]

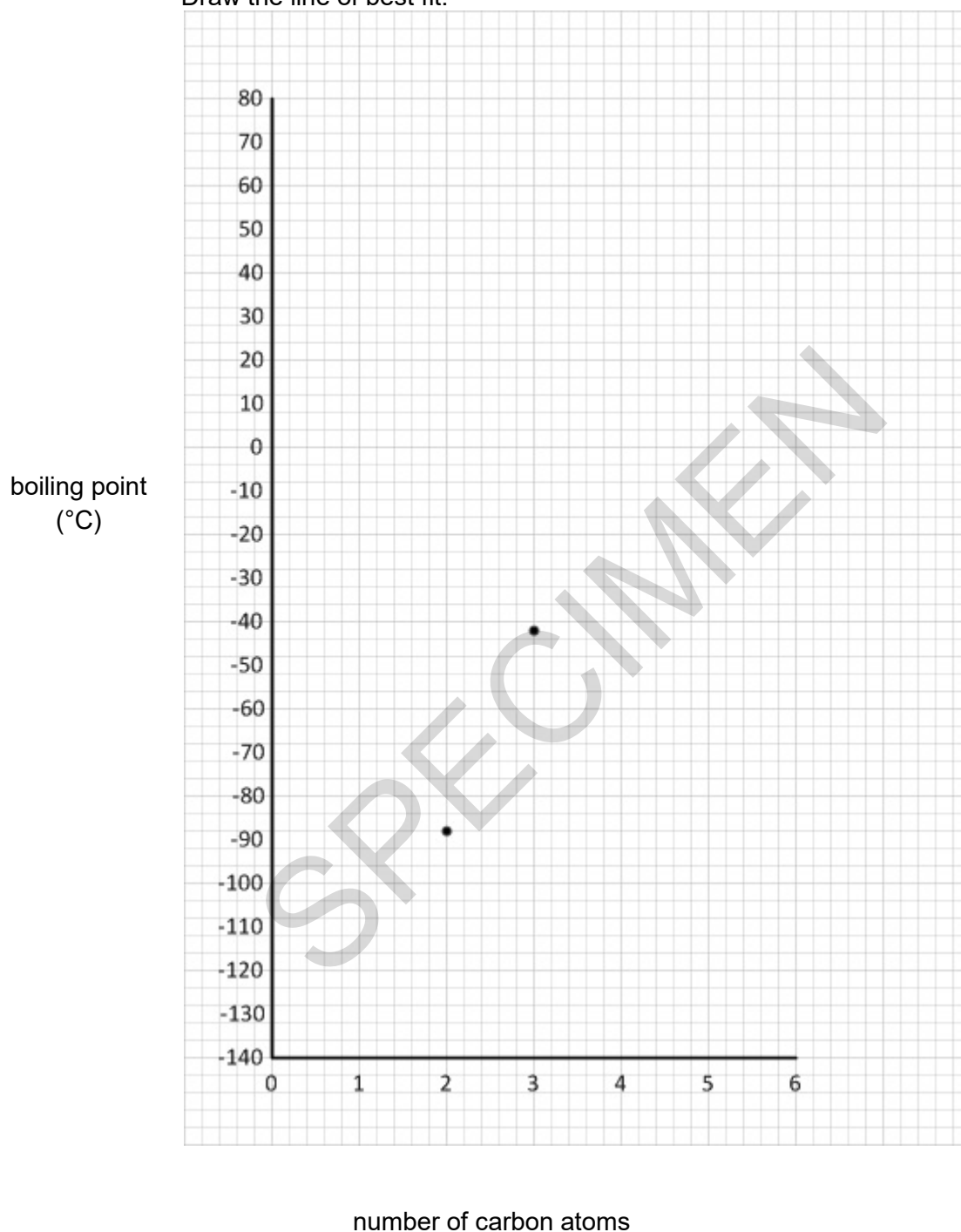

(ii) Use your graph to estimate the boiling point of butane.

answer:..... °C

[1]

- (iii) Describe the relationship between the number of carbon atoms in the molecule and its boiling point.

Use ideas about forces between molecules to explain your answer.

.....

.....

..... [2]

- (c) **Propane** burns in oxygen, O₂.

Carbon dioxide and water are made.

Write a **balanced symbol** equation for this reaction.

..... [2]

- (d) Propane gives out 50 000 J/g when it reacts with oxygen.

A propane burner is used to boil water to make a cup of tea.

63 000 J of energy are required to boil the water.

There is only 3 g of propane in the burner.

Do a calculation to find out if there is enough propane in the burner to boil the water.

[3]

- 22 (a)** Nanoparticles are used as catalysts.

Describe a property of nanoparticles that make them useful as catalysts.

.....
..... [2]

- (b)** David is synthesising a new titanium dioxide nanoparticle for use as a catalyst.

One TiO_2 nanoparticle has a mass of 5.0×10^{-3} mg.

Calculate how many TiO_2 nanoparticles are in 80.0 mg of TiO_2 .

.....
.....
..... [2]

SPECIMEN

23 Methane has the formula, CH₄.

Look at the representations of methane.



ball and stick model

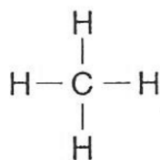

displayed formula

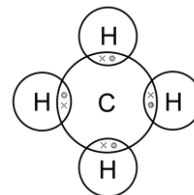

dot and cross diagram

Describe the limitations of a **displayed** formula.

.....

.....

.....

[2]

SPECIMEN

BLANK PAGE

PLEASE TURN OVER FOR THE NEXT QUESTION

SPECIMEN

- 24 Look at the table. It shows information about some atoms and ions.

Particle	Atomic number	Mass number	Number of protons	Number of neutrons	Number of electrons	Electronic structure
A	11	23	11	11	2.8.1
B	9	19	9	10	9
C	37	17	17	2.8.7
D	13	27	10	2.8

- (a) Complete the table. [4]

- (b) Particle **A** is a metal **atom**, particle **D** is an **ion**.

Explain why.

.....

.....

..... [2]

- (c) Element **C** has the electronic structure 2.8.7.

What does this tell you about the position of element **C** in the periodic table?

Explain your answer.

.....

.....

.....

..... [4]

(d) Complete the table below to give information about protons, neutrons and electrons.

	Charge	Mass in atomic mass units
proton	1
neutron
electron	negative

(e) Rutherford was a scientist who helped to develop the atomic model.

[2]

State how Rutherford's work contributed to the development of the atomic model

.....

.....

[1]

SPECIMEN

- 25 (a) The diagrams show the structures of two forms of carbon.

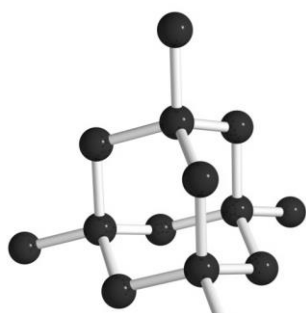

diamond

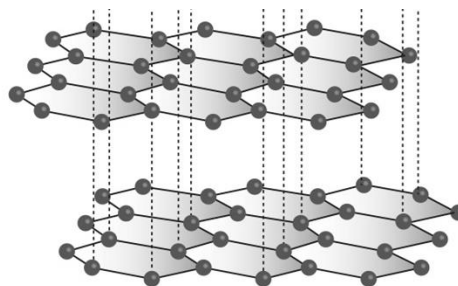

graphite

Graphite is a good conductor of electricity.

Diamond does not conduct electricity.

Use ideas about structure and bonding in diamond and graphite to explain these observations.

.....

.....

..... [3]

- (b) Carbon can form many thousands of different compounds.

Two examples are shown below.

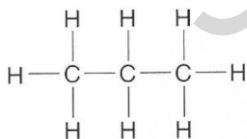

propane

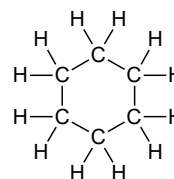

cyclohexane

Why can carbon form many thousands of different compounds?

.....

..... [1]

(c) Ethanol contains carbon.

Look at some information about ethanol.

Melting point = -114°C

Boiling point = 78°C

Predict the state of ethanol at 25°C . How can you tell?

.....
..... [2]

END OF QUESTION PAPER

SPECIMEN

SPECIMEN

Copyright Information

©Yuriy Vlasenko. Image supplied by Shutterstock. www.Shutterstock.com

OCR is committed to seeking permission to reproduce all third-party content that it uses in its assessment materials. OCR has attempted to identify and contact all copyright holders whose work is used in this paper. To avoid the issue of disclosure of answer-related information to candidates, all copyright acknowledgements are reproduced in the OCR Copyright Acknowledgements Booklet. This is produced for each series of examinations and is freely available to download from our public website (www.ocr.org.uk) after the live examination series.

If OCR has unwittingly failed to correctly acknowledge or clear any third-party content in this assessment material, OCR will be happy to correct its mistake at the earliest possible opportunity.

For queries or further information please contact the Copyright Team, First Floor, 9 Hills Road, Cambridge CB2 1GE.

OCR is part of the Cambridge Assessment Group; Cambridge Assessment is the brand name of University of Cambridge Local Examinations Syndicate (UCLES), which is itself a department of the University of Cambridge.