

GCSE (9–1) Biology B (Twenty First Century Science)

H

J257/03 Breadth in biology (Higher Tier)

Sample Question Paper

Date – Morning/Afternoon

Time allowed: 1 hour 45 minutes

You may use:

- a scientific or graphical calculator
- a ruler



○ ○ ○ ○ ○ ○

First name										
Last name										
Centre number										
Candidate number										

INSTRUCTIONS

- Use black ink.
- Complete the boxes above with your name, centre number and candidate number.
- Answer **all** the questions.
- Write your answer to each question in the space provided.
- If additional space is required, use the lined page(s) at the end of this booklet. The question number(s) must be clearly shown.
- Do **not** write in the bar codes.

INFORMATION

- The total mark for this paper is **90**.
- The marks for each question are shown in brackets [].
- This document consists of **28** pages.

1 Sarah is feeling unwell so she goes to her doctor. Her doctor thinks she may have Chronic Fatigue Syndrome (CFS).

(a) CFS is difficult to diagnose. Before diagnosis doctors rule out a condition called anaemia by carrying out a blood test.

A blood test checks the number of blood cells in Sarah's blood.

(i) What is the role of the **red** blood cell?

.....
 [1]

(ii) One symptom of CFS is extreme tiredness.

	Red blood cell (per mm ³)	White blood cell (per mm ³)	Platelets (per mm ³)
Normal level	3 800 000	8 500	250 000
Sarah	2 700 000	9 000	245 000

Explain how the results shown in the table above could cause Sarah to feel tired.

.....

[3]

- (iii) The table below shows some information about red blood cells and the cells taken from the cheek of a human.

	Red blood cell	Cheek cell
Surface area (μm^2)	136	7854
Volume (μm^3)	90	65 450
Surface area: volume ratio		0.12 : 1

Calculate the surface area to volume ratio of the red blood cell.

Show your working.

Give your answer to **two** significant figures.

..... [1]

- (iv) Red blood cells have a greater surface area to volume ratio than cheek cells.

Explain how this allows them to carry out their function.

.....

 [1]

- (v) The doctor will check to see if Sarah has an underactive thyroid gland as this could also make her feel tired.

The thyroid gland produces a hormone.

What is the role of a hormone?

.....
 [1]

(b) (i) Insulin is a hormone produced by the pancreas.

The graph below shows data from two people who were given a sugary drink.

Their blood sugar level was recorded every 60 minutes from when they had the drink.

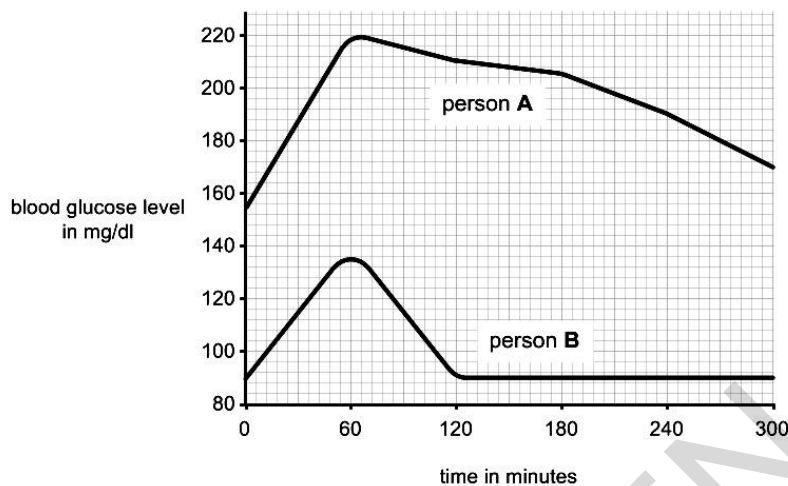

There are two types of diabetes – type 1 and type 2.

Person A has type 2 diabetes. Person B does not have diabetes.

Describe how the graph shows this and explain why there is a difference in the blood sugar level.

.....

.....

.....

.....

[2]

(ii) The statements below are all to do with type 1 and type 2 diabetes.

Draw two lines to identify the sentences which are to do with **type 1 diabetes**.

Type 1 diabetes	body no longer responds to the insulin produced
	should eat a diet high in complex carbohydrates and exercise
	will need to inject insulin
	pancreas stops producing insulin

2 Limpets are molluscs that are found on rocky shores.



Limpet

A student wants to sample a rocky shore to work out if the population of limpets differs on different parts of the shore.

(a) Describe a method that the student could use to determine where on the rocky shore there are more limpets.

.....

.....

.....

.....

.....

.....

[3]

(b) The students counted the number of limpets found on three parts of the rocky shore. The data is shown in the table below.

Part of shore	Number of limpets			Mean
	Test A	Test B	Test C	
Low shore (closest to sea)	15	16	17	
Mid shore	45	47	49	
High shore (furthest away from sea)	2	1	8	

(i) The students think one of the results is an outlier.

Circle the outlier in the table above.

[1]

(ii) Calculate the mean number of limpets found on the mid shore.

Show your working.

..... **[2]**

(c) This is a food web for the species that can live on a rocky shore.

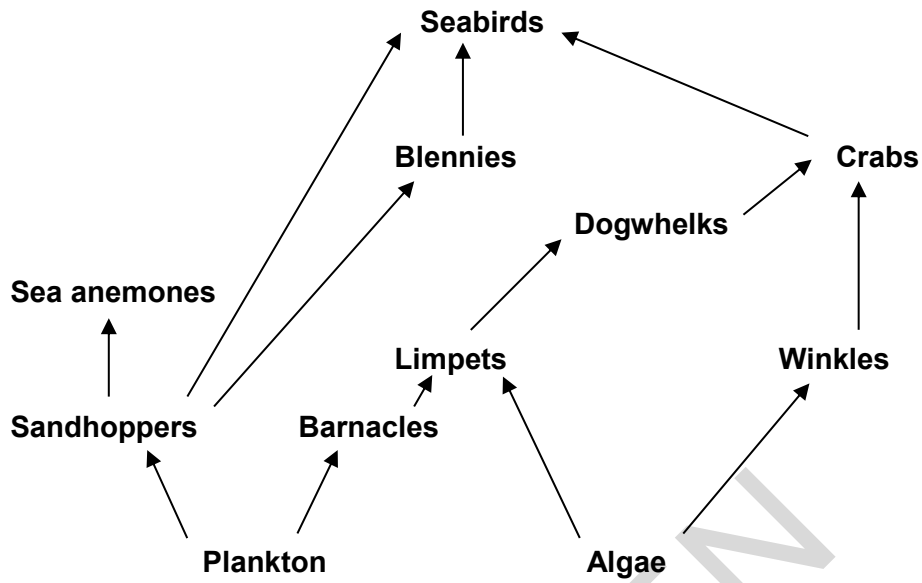

Explain the impact of an increase in the number of **dogwhelks** on one species in this food web.

.....

.....

..... [2]

(d) In some areas of the UK, dogwhelk numbers are decreasing. This reduces biodiversity.

Give **two** benefits of maintaining biodiversity.

1.....

.....

2.....

..... [2]

(e) Sea anemones can reproduce asexually.

Give **one** advantage and **one** disadvantage of this method of reproduction.

Advantage

.....

Disadvantage

.....

[2]

(f) (i) Sea anemones are mainly found in rock pools.

During the summer the water temperature in a rock pool can increase to a level which can be dangerous for a sea anemone.

Put a tick (✓) in the box that best explains why a temperature increase is a problem.

Enzyme catalysed reactions will speed up.

Enzyme catalysed reactions will slow down.

Enzymes will be killed.

Enzymes will become denatured.

[1]

(ii) When it rains, the concentration of the sea water in a rock pool decreases.

What effect will this change in concentration have on a sea anemone's cells?

Put a tick (✓) in the box next to the correct answer.

Some cells may burst.

Some cells may shrink.

There will be no change to the cells.

Some cells will burst, others will shrink.

[1]

3 DNA is a nucleic acid. DNA is found in all living cells.

(a) Read these statements about DNA.

Put ticks (✓) in the boxes next to the **two** correct statements.

DNA is made from four different nucleotides.

Half the nucleotides have a common sugar.

DNA is made from a copy of RNA.

Half the nucleotides have a phosphate group.

DNA is a polymer.

[2]

(b) RNA is another type of nucleic acid. It is involved in protein synthesis. Look at the RNA sequence.

G A C U G G A G U A C A C G C C

Use the information below and write down the sequence of amino acids that the RNA codes for.

Use the abbreviation for each amino acid.

Amino acid	Amino acid abbreviation	Nucleotide sequence
glutamic acid	glu	G A G
leucine	leu	C U G
threonine	thr	A C G
tyrosine	tyr	U A C

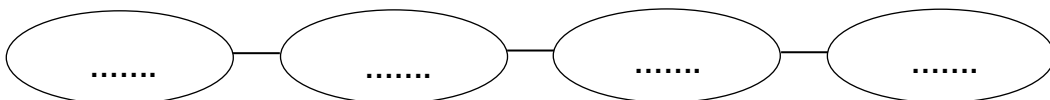

[1]

(c) A mutation occurs in the RNA sequence above. The nucleotide sequence that results is:

G A C U G U A G U A C A C G C C

Suggest what effect this could have on the production of a protein.

.....

.....

.....

.....

.....

.....

[4]

SPECIMEN

4 Jack has a bacterial infection caused by *Streptococcus pneumonia*.

A doctor takes a sample from Jack to work out which antibiotic will kill the bacteria.

The diagram below shows the effectiveness of four different antibiotics when grown on agar jelly.

The clear zone for each of the four antibiotics is shown on the diagram below. The clear zone is the area of the bacteria that has been killed by the antibiotic.

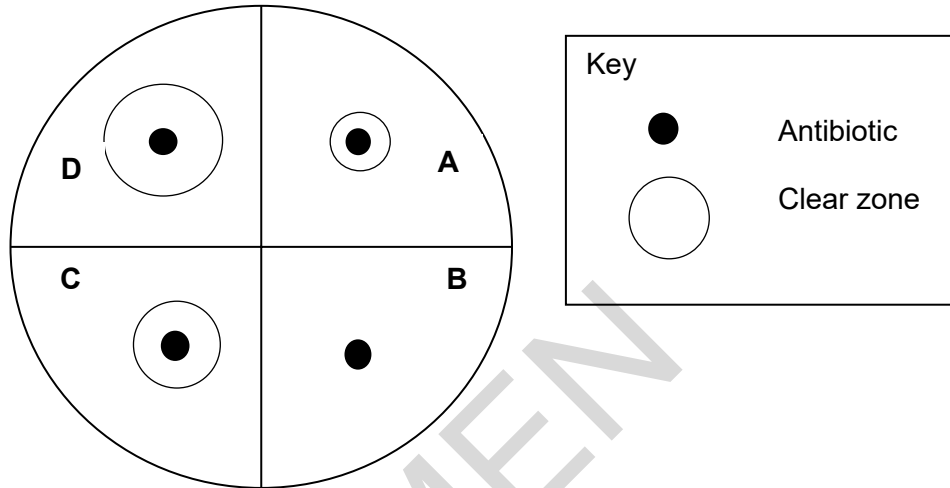

Antibiotic	Clear zone (mm ²)
A	50.24
B	0.00
C	94.99
D	

(a) (i) Using the formula πr^2 calculate the clear zone for antibiotic D.

Show your working.

$\pi = 3.14$

Clear zonemm²

[2]

(ii) Jack's doctor must decide which antibiotic to prescribe him.

Use the information provided at the start of this question to decide which of the following conclusions can be made.

Put a tick (✓) in the box next to the correct conclusion.

Antibiotic **A** works best. Jack should be given antibiotic **A**.

Antibiotic **B** has the least effect. Jack should not be given antibiotic **B**.

Antibiotic **C** works best. Jack should be given antibiotic **C**.

All antibiotics worked equally well. Jack can be given any antibiotic.

[1]

(iii) The control for this test could have been a disc which did not contain any antibiotic.

State a reason for using a control in this experiment.

.....

..... [1]

(b) Aseptic techniques must be used when culturing organisms.

Give an example of an aseptic technique and explain why it is used.

.....

.....

..... [2]

5 (a) The human menstrual cycle is controlled by hormones.

The diagram below shows the concentration of the four hormones involved in the menstrual cycle.

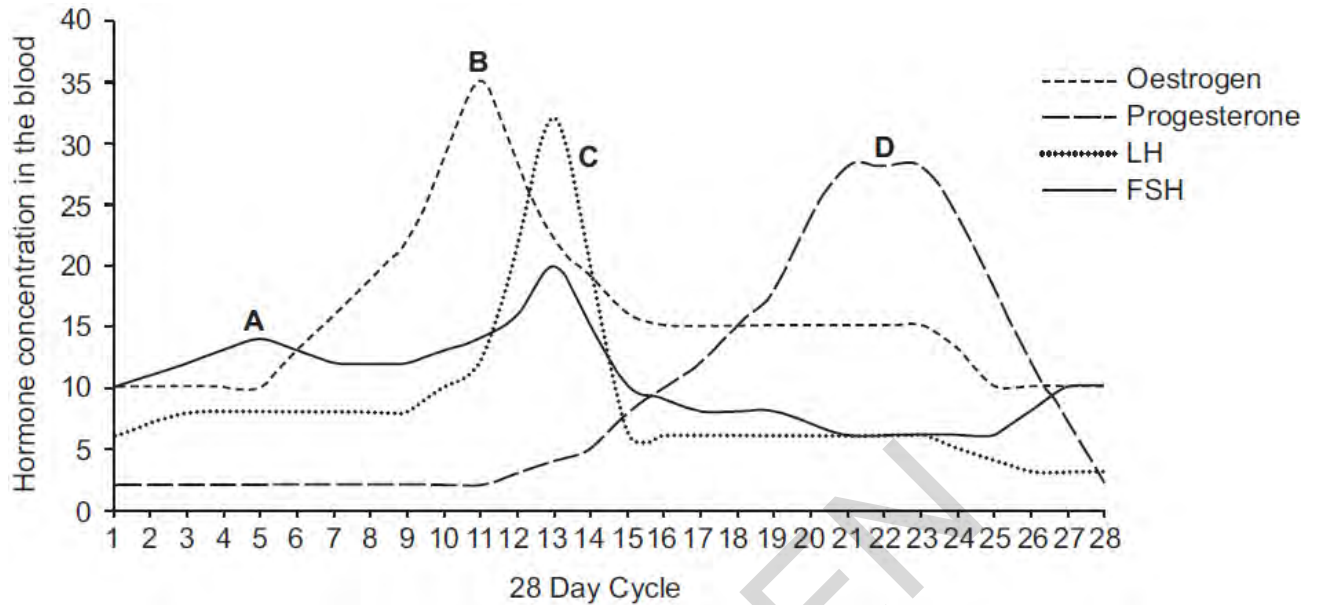

Which letter, **A**, **B**, **C** or **D**, shows when ovulation occurs?

.....

[1]

(b) Some couples are unable to conceive a child naturally. In-vitro fertilisation (IVF) is a technique that can be used to help these couples.

In IVF, a woman's ovaries are stimulated to produce a greater number of eggs than she would during a normal monthly cycle.

Which hormone could be used to achieve this?

Put a tick (✓) in the correct box.

Oestrogen	<input type="checkbox"/>
Progesterone	<input type="checkbox"/>
LH	<input type="checkbox"/>
FSH	<input type="checkbox"/>

[1]

(c) To confirm if a female is pregnant a pregnancy test will be done. These tests use monoclonal antibodies.

(i) Describe how monoclonal antibodies are produced.

.....
.....
.....
.....
.....
.....

[3]

(ii) Antibodies are proteins.

The statements below describe protein synthesis.

- A The mRNA travels to a ribosome in the cytoplasm.
- B A copy of the gene is made from messenger RNA.
- C The ribosome joins the amino acids together in the correct order.
- D The gene that codes for the protein is found in the DNA.

Put the statements in the correct order.

.....

[1]

6 Look at the diagram of the heart.

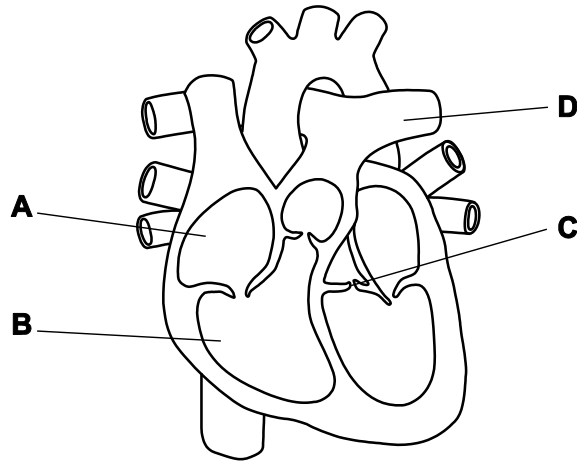

(a) (i) Which letter on the diagram, **A**, **B**, **C** or **D**, shows how the backflow of blood is prevented?

Place a tick (✓) in the correct box.

A	
B	
C	
D	

[1]

(ii) The blood vessels in the circulatory system are adapted to their function.

The table below highlights the features of the three different blood vessels.

Use the table to identify the **type** of blood vessel, X, Y and Z.

Vessel	Smooth inner lining	Valves	Muscular tissue	Elastic tissue
X	Yes	Yes	Yes	Yes
Y	Yes	No	Yes	Yes
Z	Yes	No	No	No

Blood vessel X

Blood vessel Y

Blood vessel Z

[3]

- (b) A scientist collected some data about the percentage of fat in people's diet and the number of deaths from heart disease in various countries around the world.

The data was plotted in the graph below.

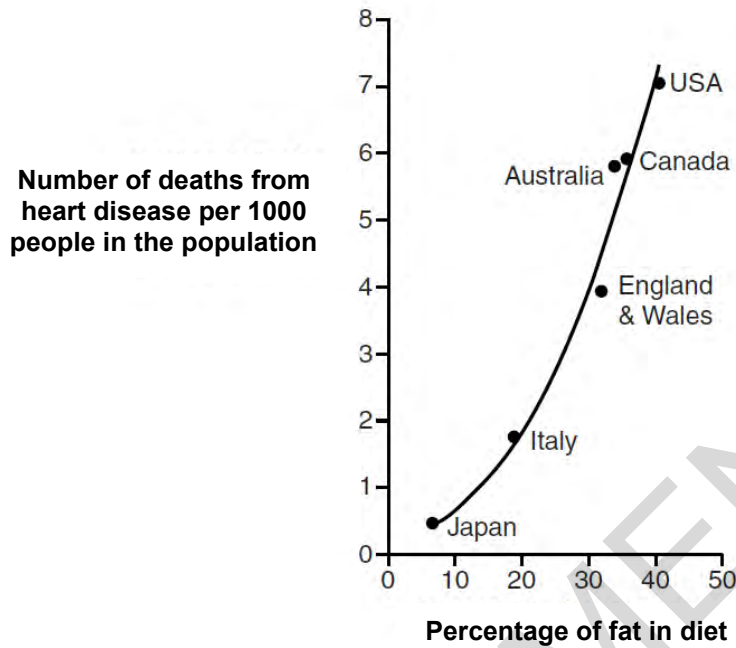

- (i) What can you conclude about the percentage of fat in the diet and the likelihood of dying from heart disease?

..... [1]

- (ii) What **two** lifestyle changes might you suggest to a person from the USA in order to decrease their chance of dying from heart disease?

1.....

2.....

[2]

(c) Some diseases are inherited.

Haemophilia is an example of an inherited disease. It is caused by a **recessive allele**. The gene for haemophilia is located on the sex chromosomes.

Due to the location of the gene for haemophilia, females inherit two copies of the gene, but males only inherit one. For a male, this is shown on the diagram below.

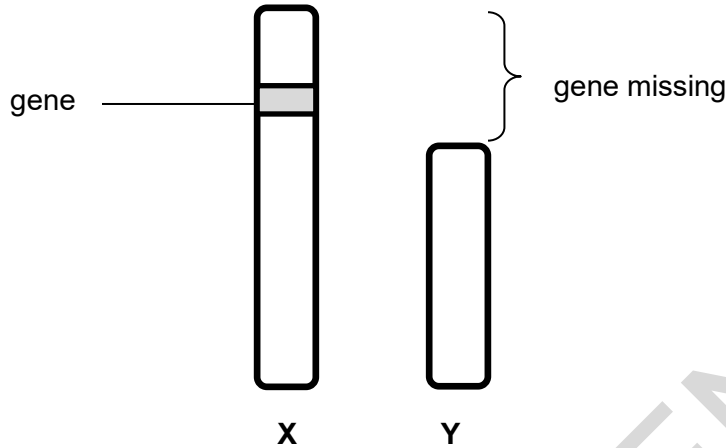

Males **cannot** be carriers for the disease. They either have the disease or they do not.

(i) Complete the Punnet square to determine the probability of a female carrier with the genotype $X^H X^h$ and a healthy male with the genotype $X^H Y$ having a son with haemophilia.

	X^H	X^h
X^H		
Y		

Probability..... [2]

(ii) Which of the following genotypes would a female with haemophilia have?

Put a tick (✓) in the correct box.

- $X^H X^H$
- $X^H X^h$
- $X^h X^h$
- $X^H X$

[1]

- 7 (a) (i) Nat has an eye disease that causes the fibres that hold her cornea in place to weaken. Her cornea has become damaged causing its shape to change.

What is the role of the cornea and how will damage to the shape affect Nat's sight?

.....
.....
.....
.....

[2]

- (ii) Scientists are now using stem cells to repair damage to corneas.

What is a stem cell?

.....
.....

[1]

- (iii) Stem cells can be obtained from embryos.

Why are some people against using embryos as a source of stem cells?

.....
.....

[1]

SPECIMEN

- (b) New body cells are created as part of the cell cycle. This is represented in the diagram below.

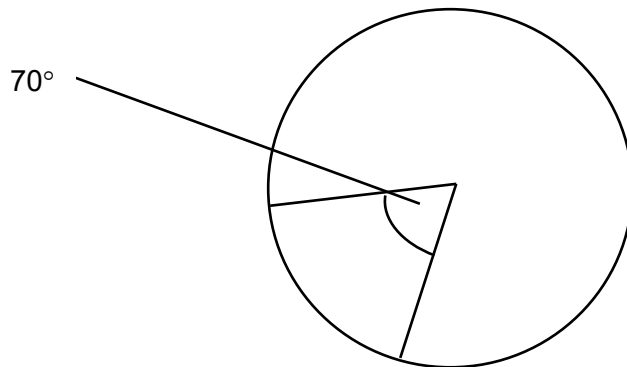

The whole cell cycle, in this example, takes 141 minutes.

Calculate the length of time spent in mitosis.

Give your answer to 2 decimal places.

time spent in mitosis minutes [2]

8 A student investigates the effect of temperature on the rate of water uptake by a plant.

(a) She places a plant shoot in a room at 35°C and sets the equipment up as shown below.

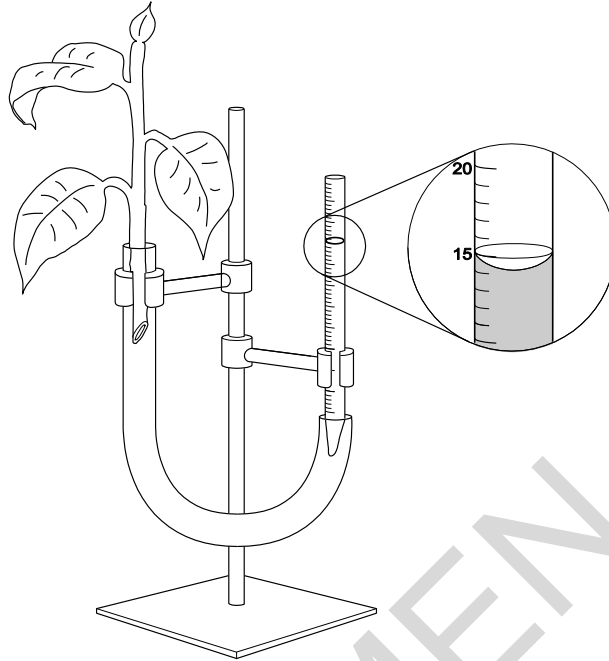

(i) The student measured the distance moved by the air bubble over a period of 30 minutes. The diagrams below show her results.

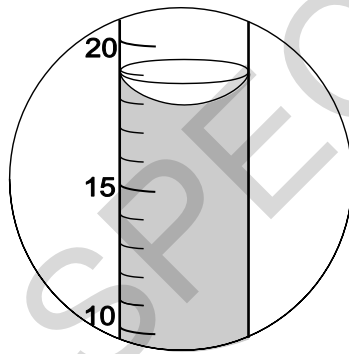

Air bubble before

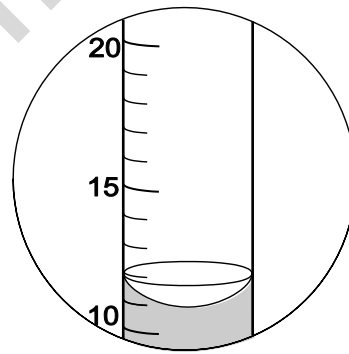

Air bubble after

Calculate the rate of water uptake.

Show your working.

Give your answer to 2 significant figures.

rate of water uptake = cm³/min [2]

(ii) How could the student use this apparatus to investigate the rate of water uptake in windy conditions?

Other apparatus is available, too.

.....
..... [1]

(iii) The volume of water taken up may not be an accurate measurement of the water lost in transpiration.

Suggest why.

.....
..... [2]

(b) Stomata are small holes found mostly on the underside of leaves.

They can open and close. The opening and closing of the stomata is controlled by guard cells.

The diagram below shows the stomata and the guard cells.

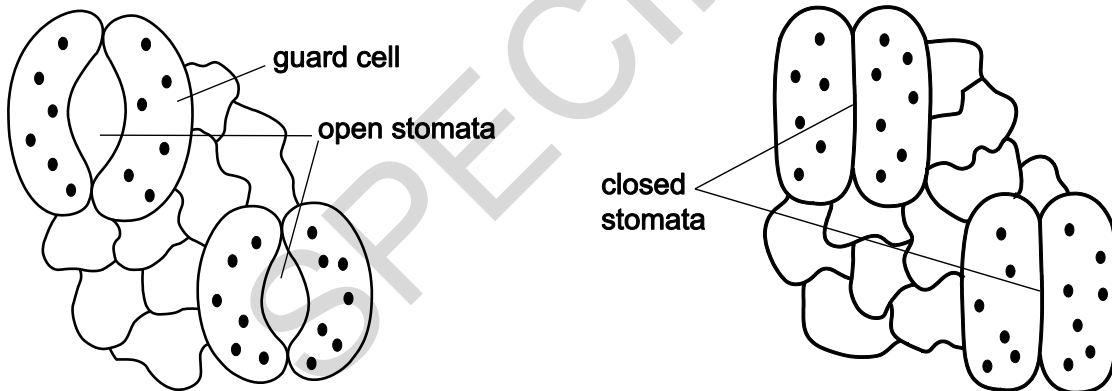

Potassium ions from neighbouring cells enter the guard cells. This causes the stomata to open.

Explain how this mechanism works.

.....
.....
..... [2]

9 (a) In 1991 a type of genetically modified tomato was being developed.

This tomato contained a gene from the arctic flounder fish.

Arctic flounder fish live in very cold conditions.

How would the tomato with the arctic flounder fish gene be of benefit to modern agriculture?

.....
..... [1]

(b) Genetic modification has many wider applications.

Children who lack human growth hormone can now have a genetically engineered version injected so that they grow as normally as possible.

The bacterium *Escherichia coli* is used as part of the genetic engineering process.

Use this information to describe how human growth hormone is made.

.....
.....
.....
.....
.....
.....
.....
.....
..... [3]

SPECIMEN

10 (a) Whooping cough is a non-communicable bacterial infection.

The diagram below shows the blood of a person infected with whooping cough.

Label the two structures in the diagram.

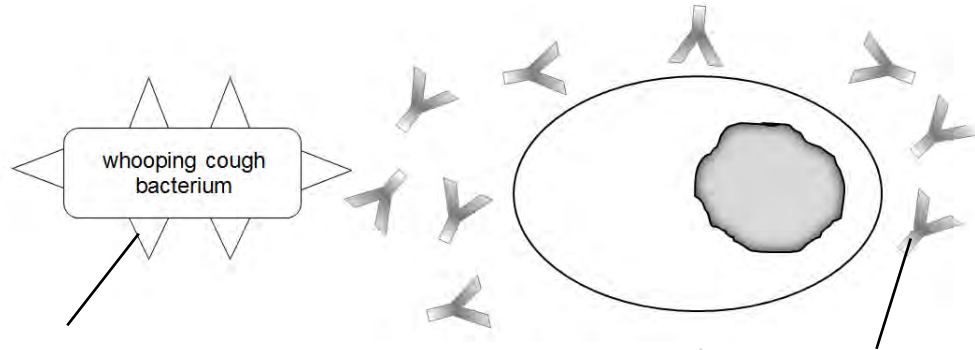

(i)

(ii)

[2]

(iii) We can vaccinate against whooping cough.

There are 2 types of vaccine. Type 1 uses whole bacterial cells, type 2 uses parts of bacterial cells.

Some people are concerned about using the whole bacterial cell vaccine.

Suggest why.

.....
.....

[1]

- (b) New medicines, including vaccinations, have to be tested before they are made widely available.

Preclinical and clinical tests are used to assess the safety and effectiveness of new medicines.

For each test, complete the table by putting a tick (✓), in **one** box next to the test to indicate if it assesses **safety**, **effectiveness** or **both**.

For each test, one example has been done for you.

Preclinical tests	Safety	Effectiveness	Both
Cultured human cells			✓
Whole animals			

Clinical tests	Safety	Effectiveness	Both
Healthy volunteers			
Humans with the disease			✓

[2]

- 11 (a) James Watson and Francis Crick are famous for identifying the structure of DNA. They wrote a scientific paper about it in 1953. Before this, scientists had clues about the parts of the DNA molecule.

One of these clues was to do with the relative amounts of the bases – A, T, C and G. Chemical analysis of DNA from a wide variety of cells showed that the total number of A bases and G bases equalled the total number of T bases and C bases.

What conclusion could early scientists have made from this analysis?

.....
.....
..... [2]

- (b) DNA structure is important in the production of proteins. DNA analysis allows scientists to group organisms based on similarities in their DNA.

Complete the sentences below.

A of bases is required to code for an amino acid.

The properties of the protein made depend on the of the amino acids.

Grouping organisms according to similarities in their DNA or physical characteristics is called

..... [3]

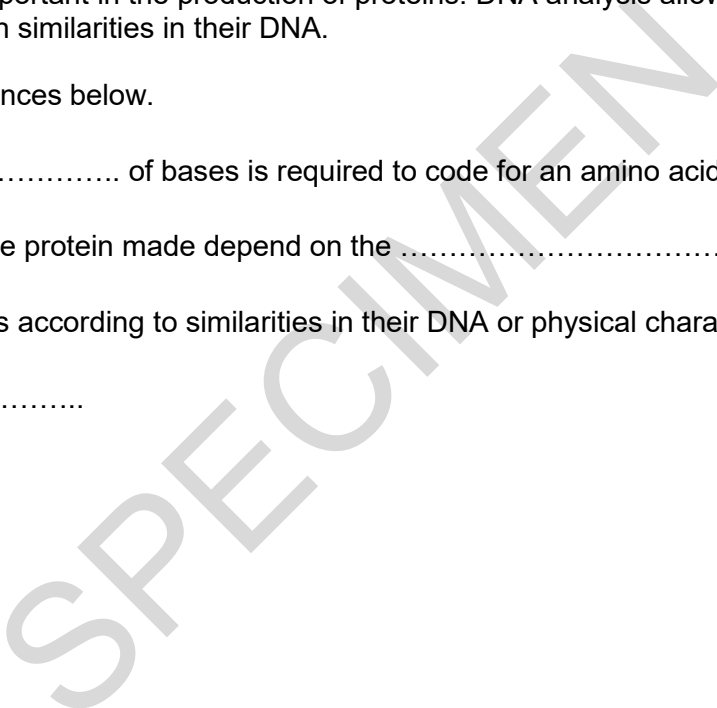

- (c) Knowledge of genetics and DNA analysis has allowed scientists to group organisms based on similarities in their DNA.

It also enables them to draw conclusions about the evolutionary relationships between organisms.

It is possible to draw an evolutionary tree as seen below to highlight these relationships.

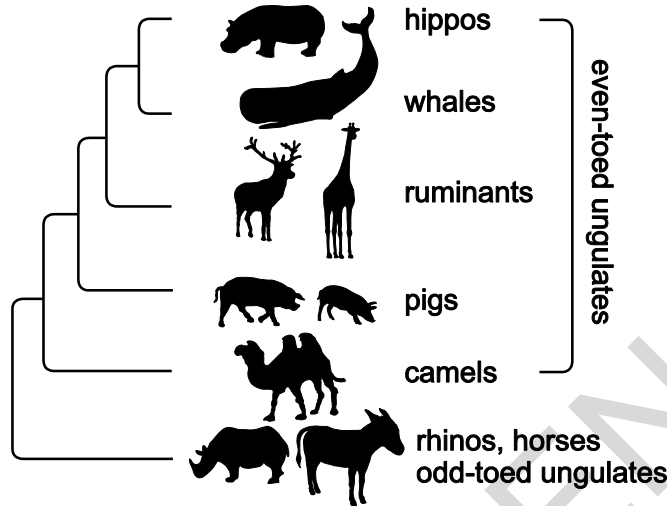

Are hippos more closely related to whales or to pigs?

Justify your answer using evidence from the evolutionary tree in your answer.

.....

.....

.....

[2]

- 12 (a) Sunil considers different ways to display data about the organisms found in a woodland ecosystem.

One option is a pyramid of numbers for the simple food chain:

Oak tree → Yellow-necked caterpillar → Blackbird

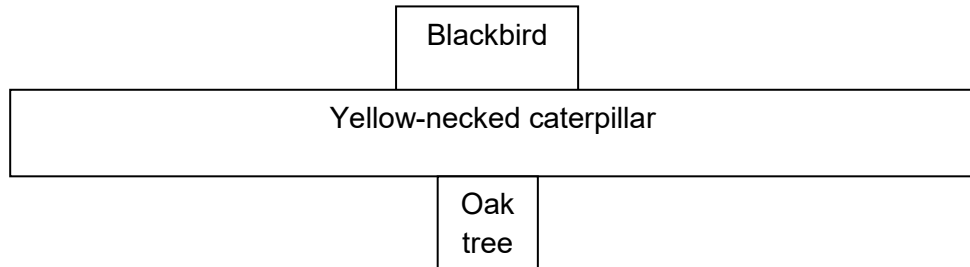

Draw a pyramid of biomass for this food chain in the space below.

[1]

- (b) Biomass in an ecosystem can be measured in g/m^2 .

The following are possible values for a different food chain in the same woodland ecosystem.

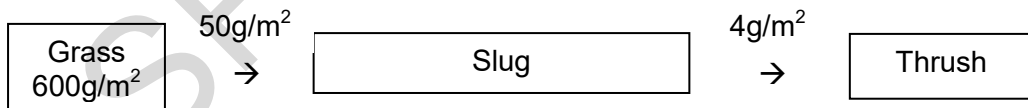

- (i) Calculate the percentage of the biomass from the grass that is passed on to the thrush.

Show your working. Give your answer to 2 decimal places.

..... [1]

(ii) Give **one** reason why so little biomass from the grass is passed on to the thrush.

1.....
..... [1]

(c) Decomposers are also an important part of ecosystems.

The graph below shows the activity of decomposers in a woodland ecosystem during a year, from January to December.

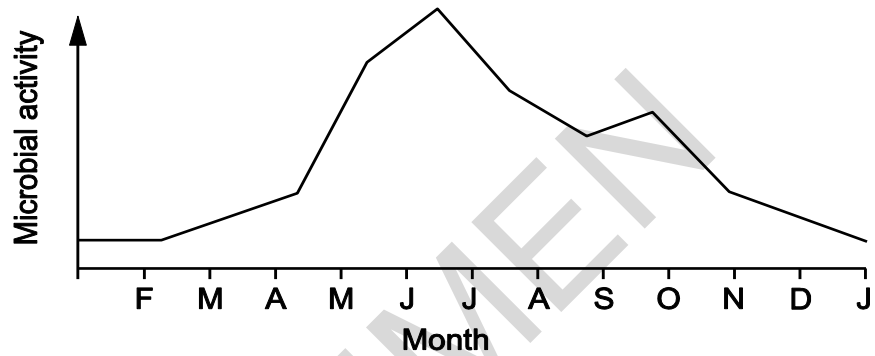

(i) Describe the pattern of microbial activity shown in the graph above.

.....
.....
.....
..... [2]

(ii) Explain the pattern you have described in (c)(i).

.....
.....
.....
..... [2]

END OF QUESTION PAPER