

Sc

KEY STAGE  
3

TIER  
5–7

2003

# Science test

## Paper 2

Please read this page, but do not open the booklet until your teacher tells you to start. Write your name and the name of your school in the spaces below.

First name \_\_\_\_\_

Last name \_\_\_\_\_

School \_\_\_\_\_

### Remember

- The test is 1 hour long.
- You will need: pen, pencil, rubber, ruler, protractor and calculator.
- The test starts with easier questions.
- Try to answer all of the questions.
- Write all your answers on the test paper – do not use any rough paper.
- Check your work carefully.
- Ask your teacher if you are not sure what to do.

For marker's  
use only

Total marks

Borderline check

1. Nadia is on her bicycle, waiting to pull out from a road junction. Michael is driving his car round the bend. A row of houses stops Nadia from seeing Michael's car.

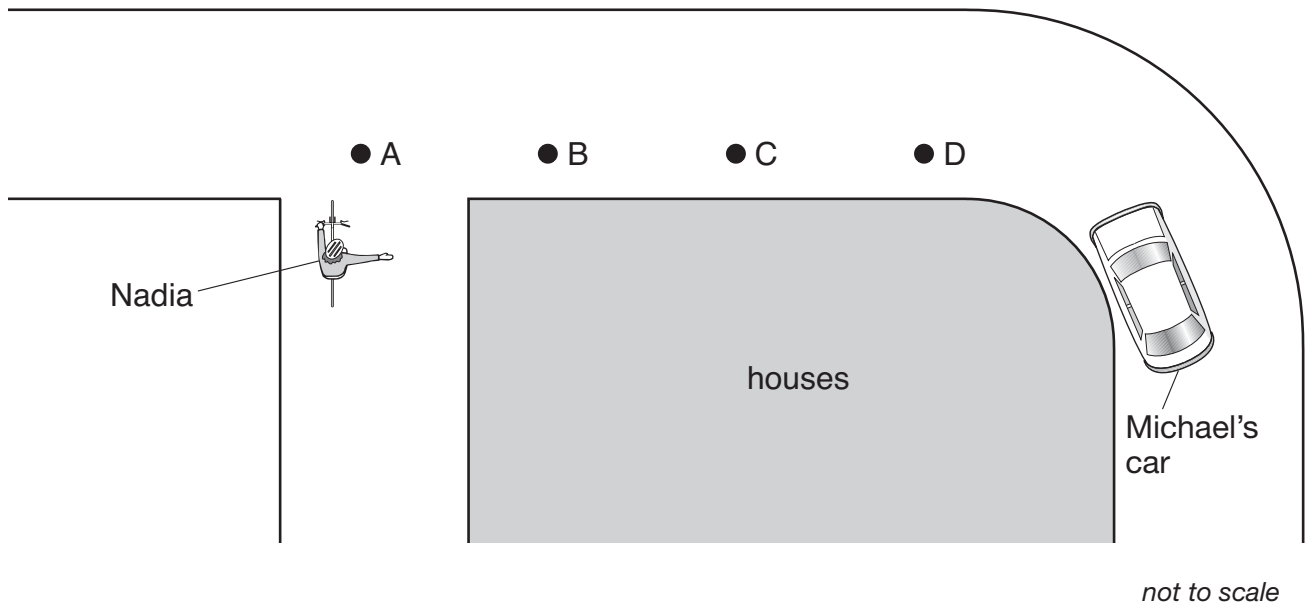

- (a) At what position will Michael's car be when Nadia first sees it?  
Tick the correct box.

1 mark

A       B       C       D

- (b) A row of shops was built opposite the junction. The shops have glass windows which act as a mirror.

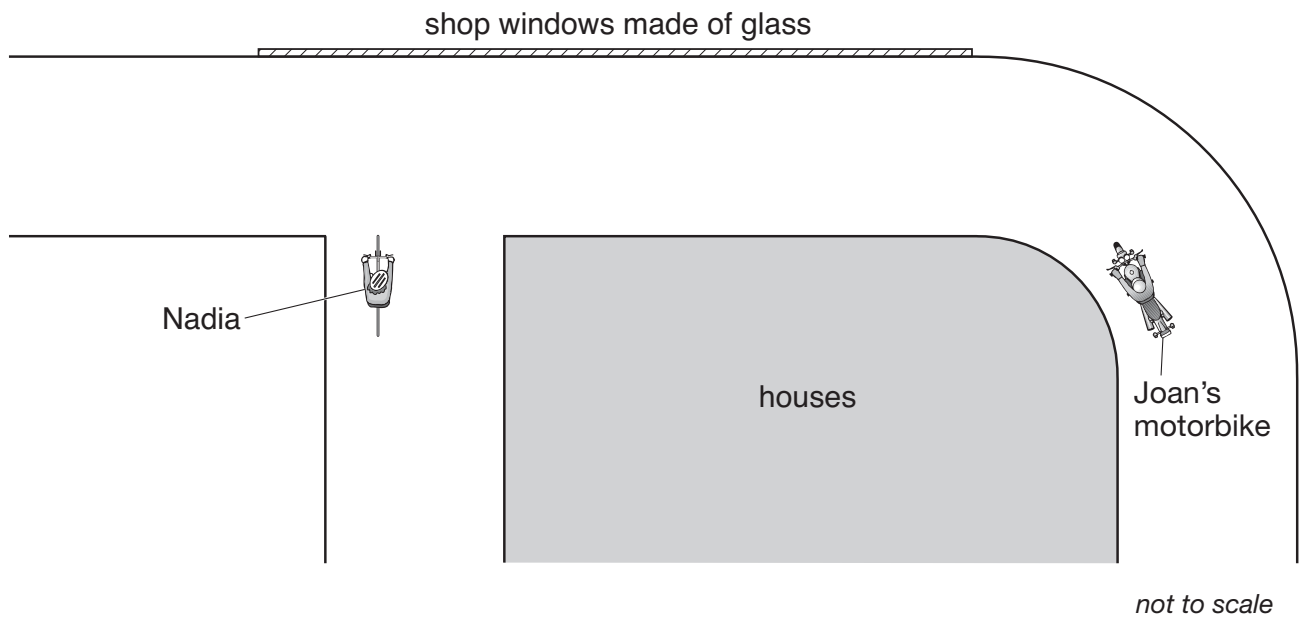

Nadia could see Joan's motorbike reflected in the glass window.

- (i) **On the diagram above**, draw a ray of light to show how Nadia can see Joan's motorbike reflected in the glass window. Add arrows to the ray. Use a ruler.

3 marks

- (ii) How does the glass window help to reduce the number of accidents?

1 mark

---

---

maximum 5 marks

2. (a) Jacquie has a mobile phone. Energy is stored in the battery of the phone. The drawing shows the battery being charged.

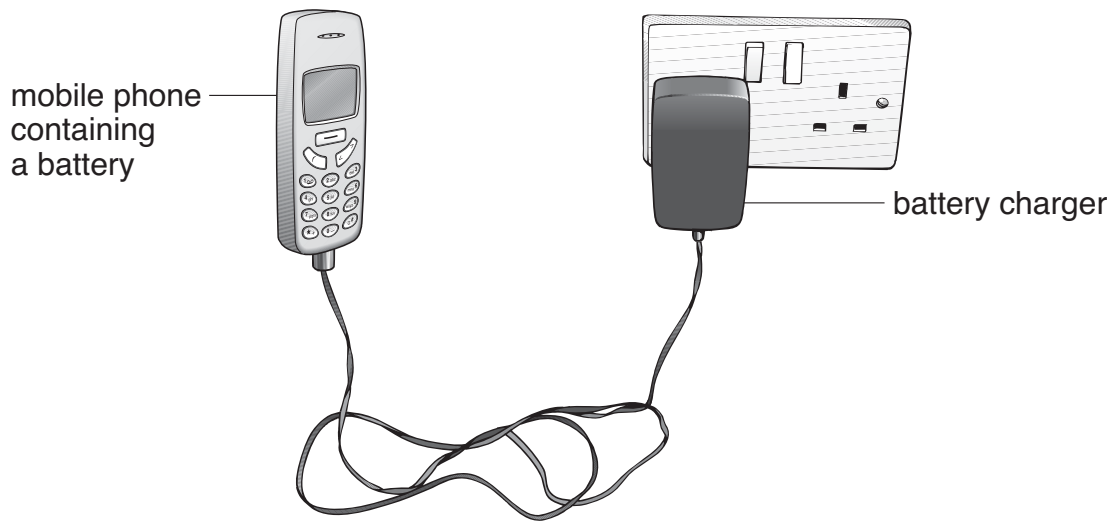

- (i) Which energy transfer takes place in the battery as it is being charged?  
Tick the correct box.

1 mark

chemical to sound	<input type="checkbox"/>	sound to thermal	<input type="checkbox"/>
electrical to chemical	<input type="checkbox"/>	thermal to electrical	<input type="checkbox"/>

- (ii) When the battery is fully charged, Jacquie unplugs the phone.

Which energy transfers take place when the mobile phone rings?  
Tick the correct box.

1 mark



chemical to electrical to sound	<input type="checkbox"/>
electrical to chemical to sound	<input type="checkbox"/>
kinetic to electrical to sound	<input type="checkbox"/>
thermal to electrical to sound	<input type="checkbox"/>

- (b) Jacquie can change the ring-tone of her phone.  
The diagrams below show the patterns made by four sound waves on an oscilloscope screen.  
They are all drawn to the same scale.

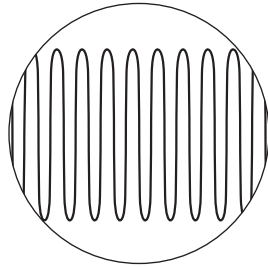

P

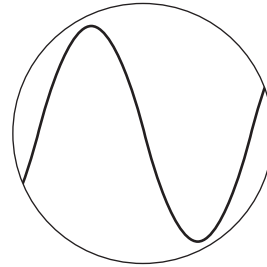

Q

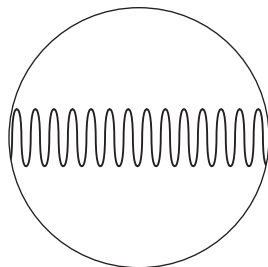

R

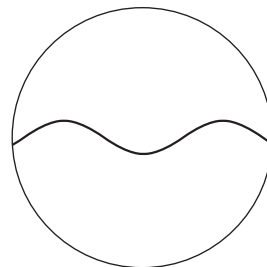

S

Write the letter of the sound wave that matches each of the descriptions below.

3 marks

- (i) a loud sound with a low pitch \_\_\_\_\_  
(ii) a quiet sound with a high pitch \_\_\_\_\_  
(iii) a loud sound with a high pitch \_\_\_\_\_

maximum 5 marks



3. Anil sits on a mat at the top of a helter-skelter and then slides down a chute around the outside.

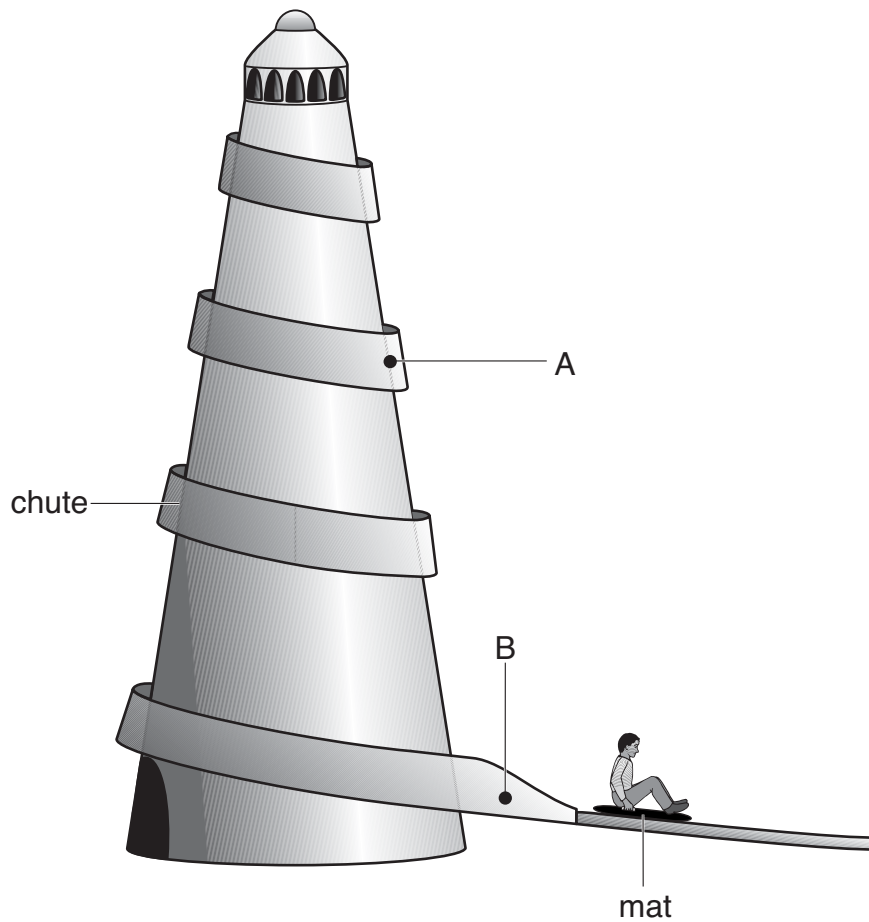

- (a) (i) Name **two** of the forces acting on Anil as he slides from point A to point B.

2 marks

1. \_\_\_\_\_  
2. \_\_\_\_\_

- (ii) As Anil slides from point A to point B, the forces acting on him are balanced.

Describe Anil's speed when the forces acting on him are balanced.

1 mark

\_\_\_\_\_

- 
- (b) Anil goes back for a second go. This time he sits on a smooth cushion instead of a mat.

He goes much faster on the cushion. Give the reason for this.

*1 mark*

---

- (c) On his third go Anil lies back on the cushion with his arms by his side.

What happens to his speed? Give the reason for your answer.

*2 marks*

---

---

---

*maximum 6 marks*



4. Sailors used to suffer from an illness called scurvy caused by a poor diet on long journeys.  
James Lind was a doctor who tested treatments for scurvy. He predicted that **all acids cure scurvy**.



I think that all acids will cure scurvy.

He gave 6 pairs of sailors with scurvy exactly the same meals but he also gave each pair a different addition to their diet.

pair of sailors	addition to their diet	effect after one week
1	some apple cider	beginning to recover
2	25 drops of very dilute sulphuric acid to gargle with*	still had scurvy
3	2 teaspoons of vinegar	still had scurvy
4	half a pint of sea water*	still had scurvy
5	2 oranges and 1 lemon	recovered
6	herbs and spices and acidified barley water	still had scurvy

- (a) Does the evidence in the table support the prediction that all acids cure scurvy?  
Tick the correct box.

yes

no

Use the table to explain your answer.

1 mark

---



---

**\*DANGER! DO NOT TRY THIS.**



- 
- (b) (i) Give the **one** factor James Lind **changed** in this experiment.  
(This is called the independent variable.)

1 mark

---

- (ii) Give the factor James Lind **examined** in this experiment.  
(This is called the dependent variable.)

1 mark

---

- (c) James Lind's evidence suggested that oranges and lemons cured scurvy.

At a later time, other scientists did the following:

- They separated citric acid from the fruit.
- They predicted that citric acid would cure scurvy.
- They tested their prediction by giving pure citric acid as an addition to the diet of sailors with scurvy.
- They found it did **not** cure scurvy.

The scientists had to make a different prediction.

Suggest a new prediction about a cure for scurvy that is consistent with the evidence collected.

1 mark

---

---

- (d) Explain why it is necessary to investigate the effects of changes in diet over a period of more than one week.

1 mark

---

---

---

---

maximum 5 marks



5. (a) George used the apparatus below to find out what substances are produced when methanol burns.

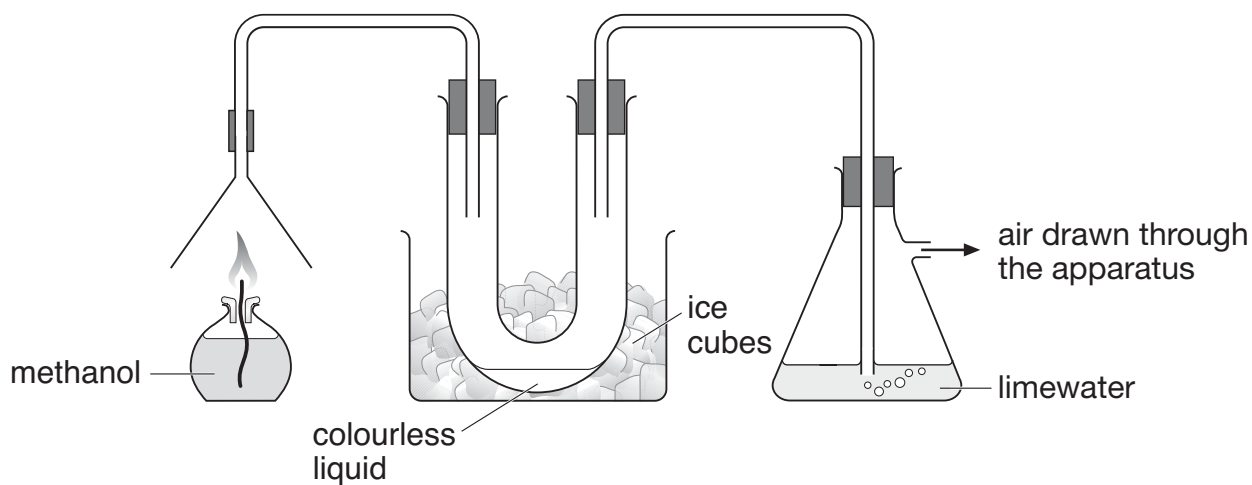

As the methanol burned, two different gases were produced.

- (i) One of these gases condensed in the U-tube to give a colourless liquid.  
Give the name of this liquid.

1 mark

\_\_\_\_\_

- (ii) The other gas turned the limewater cloudy.  
Give the name of this gas.

1 mark

\_\_\_\_\_

- (b) Methanol is sometimes used in antifreeze. It can be added to water in car windscreen wash-bottles to prevent the water from freezing in cold conditions.



- (i) The label on the bottle of antifreeze has two hazard warning symbols. What **two** precautions would you need to take when using this antifreeze?

1. \_\_\_\_\_

\_\_\_\_\_

2. \_\_\_\_\_

\_\_\_\_\_

1 mark

- (ii) Water freezes at 0°C. The label on the bottle shows how the freezing point changes when different amounts of antifreeze are added to water.

Terry put a mixture containing 10% antifreeze into the wash-bottle of his car. During the night the temperature dropped to -14°C. The wash-bottle burst.

Explain why the wash-bottle burst.

2 marks

\_\_\_\_\_

\_\_\_\_\_

\_\_\_\_\_

\_\_\_\_\_

maximum 5 marks



6. Sarah and Jim investigated the effect of temperature on the solubility of copper sulphate.

They dissolved copper sulphate crystals in the same volume of water until **no** more would dissolve. This means the solution was saturated. They measured the mass of copper sulphate needed to make a saturated solution using water at different temperatures.

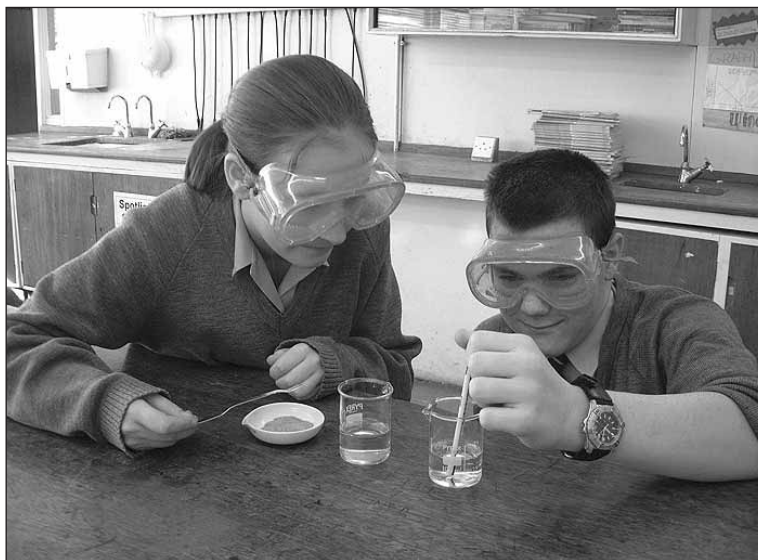

They plotted their results on a grid.

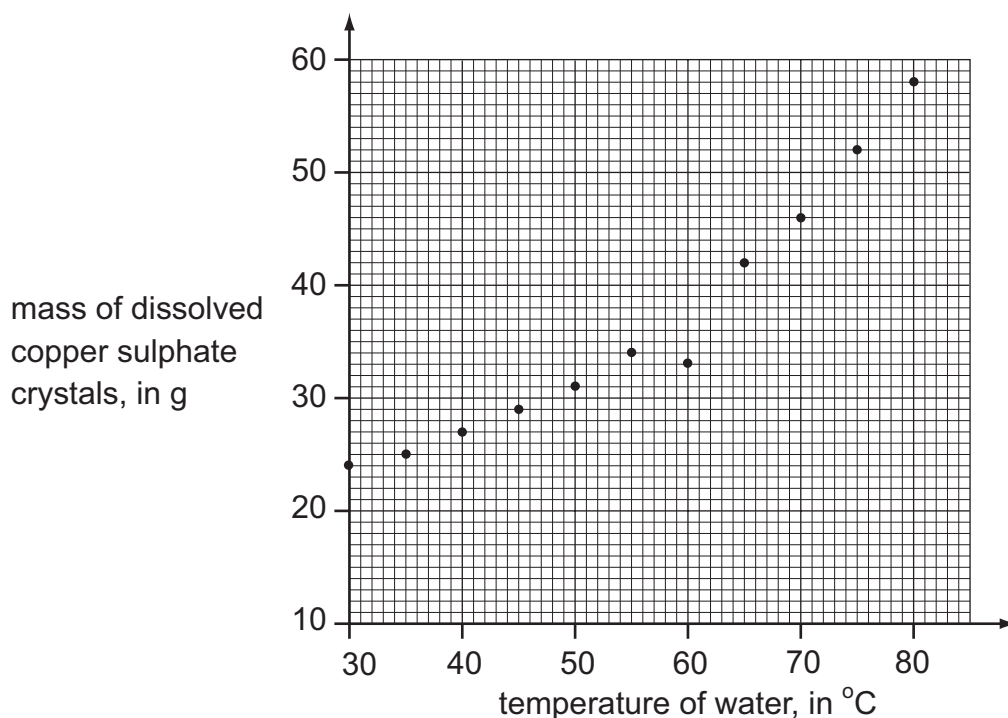

- (a) (i) One of the mass readings appears to be wrong (anomalous).

Circle the anomalous result on the graph.

1 mark

---

(ii) Draw a smooth curve of best fit on the graph.

1 mark

(iii) Use the graph to predict a more likely measurement of mass for the anomalous result.

1 mark

\_\_\_\_\_ g

(b) Suggest **one** mistake Sarah and Jim might have made to produce this anomalous result.

1 mark

---

---

maximum 4 marks

7. Diagram 1 below shows the lungs and the trachea, the airway leading to the lungs. One of the lungs is drawn in section.

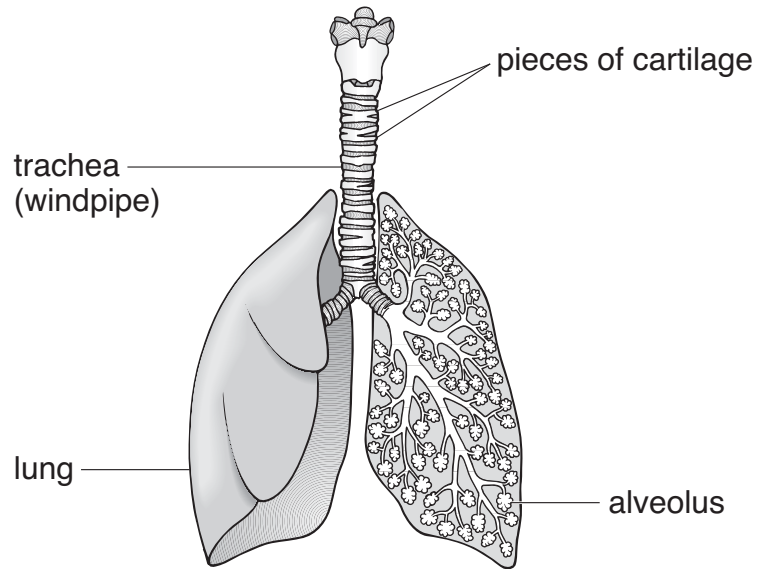

**diagram 1**

- (a) In the wall of the trachea, there are pieces of a stiff material called cartilage.

Why is this stiff material necessary in the wall of the trachea?

1 mark

---

---

- (b) Diagram 2 below shows one alveolus and its blood supply.

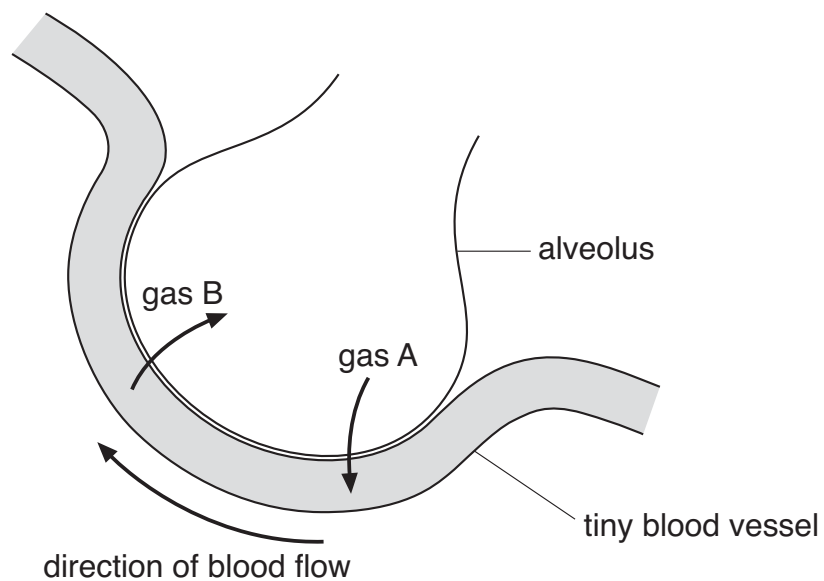

**diagram 2**

- (i) Look at diagram 2, opposite.  
Gas A **enters** the blood from the alveolus.  
Gas B **leaves** the blood and enters the alveolus.  
What are the names of gases A and B?

1 mark

gas A \_\_\_\_\_

gas B \_\_\_\_\_

- (ii) Give **one** reason why it is easy for gases to pass across the wall of an alveolus.

1 mark

\_\_\_\_\_

\_\_\_\_\_

- (c) The diagram below shows a ciliated cell from the lining of the airway.

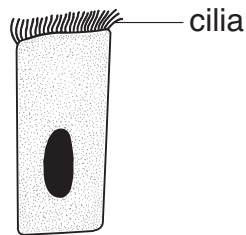

- (i) What is the function of this cell in the airway?

1 mark

\_\_\_\_\_

\_\_\_\_\_

- (ii) This cell is affected by substances in cigarette smoke.  
What effect does cigarette smoke have on the cilia?

1 mark

\_\_\_\_\_

\_\_\_\_\_

- (iii) Give the name of the substance, in cigarette smoke, which causes addiction to smoking.

1 mark

\_\_\_\_\_

maximum 6 marks

---

8. The diagram shows a section through the female reproductive system.

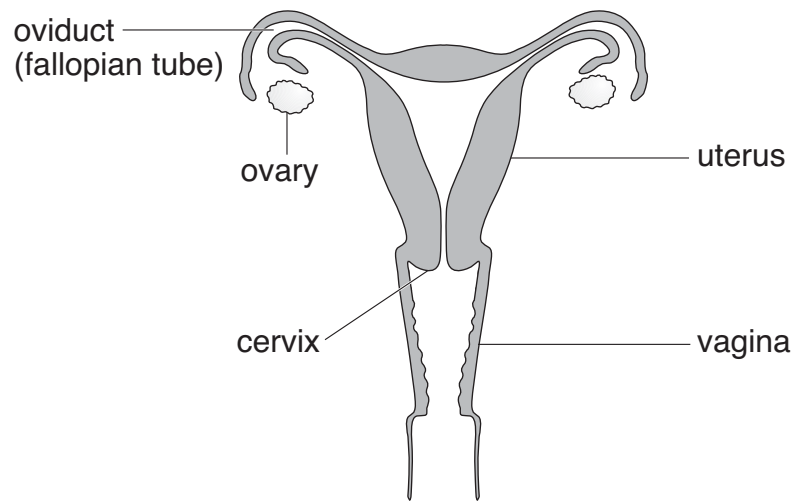

(a) (i) What happens at fertilisation?

1 mark

---

---

(ii) In which labelled part of the female reproductive system does fertilisation normally take place?

1 mark

---

(iii) In which labelled part of the female reproductive system does the foetus develop?

1 mark

---



- 
- (b) Some women have blocked oviducts.  
How do blocked oviducts prevent fertilisation taking place?

*1 mark*

---

---

- (c) When a baby is born it is pushed out of the mother's body.  
Describe what happens in the wall of the uterus to push the baby out.

*1 mark*

---

---

*maximum 5 marks*

9. Linda had a piece of red sandstone.

She hammered it into pieces and then ground them into a powder using a pestle and mortar.

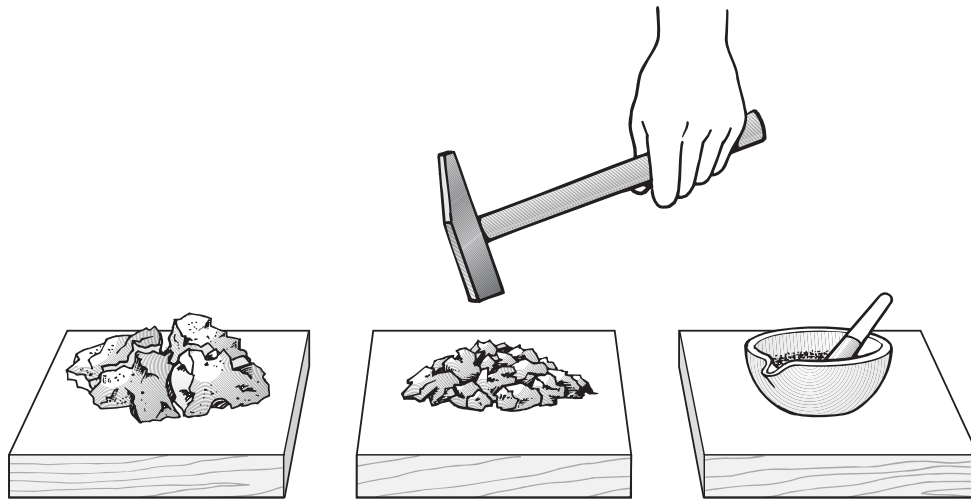

She put the powder into a measuring cylinder with water and shook the mixture. The contents settled.

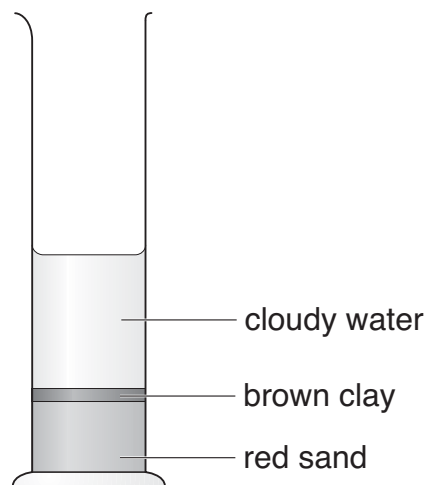

(a) Linda said her results showed that sandstone is a mixture of two substances.

How could she tell, from the results, that sandstone is a mixture of substances?

1 mark

---

---



10. Peter measured the current through each of three similar bulbs in a parallel circuit.

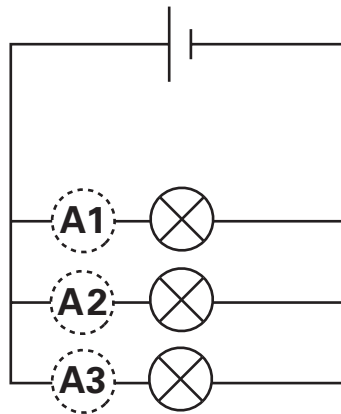

He had only one ammeter and he placed it first at **A1**, then **A2**, then **A3**, in order to measure the currents.

The table shows his results.

position of ammeter	current, in amps
A1	0.14
A2	0.16
A3	0.15

- (a) He expected the current readings to be the **same** for each bulb but found they were **different**.

Suggest **two** reasons why the readings were different.

2 marks

1. \_\_\_\_\_

2. \_\_\_\_\_

- (b) Peter then measured the current at **A4** and recorded it as 0.45 A. He concluded that the current at **A4** could be calculated by adding together the currents through each of the bulbs at positions **A1**, **A2** and **A3**

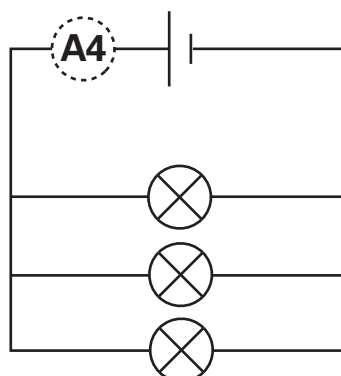

He added two more similar bulbs to his circuit, in parallel.  
 The current through each bulb was 0.15 A.  
 Use Peter's conclusion to predict the current at **A4** with the 5 bulbs in the circuit.

1 mark

\_\_\_\_\_ A

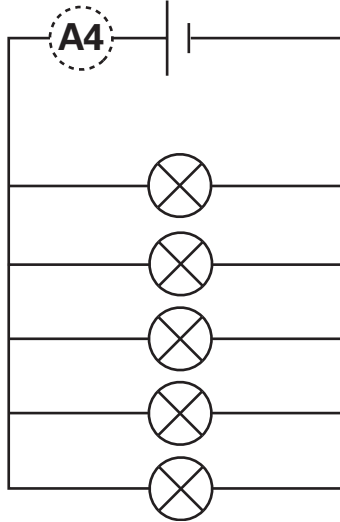

- (c) Peter left the circuit connected overnight. He used a datalogger to measure the current at position **A4** at regular intervals of time. The next morning the bulbs were dim.

Using the axes below, sketch (do **not** plot) how the current at position **A4** might change with time.

Indicate on the graph:

- (i) The correct labels for each axis, including the correct units.
- (ii) The shape of the graph you would expect to obtain.

2 marks

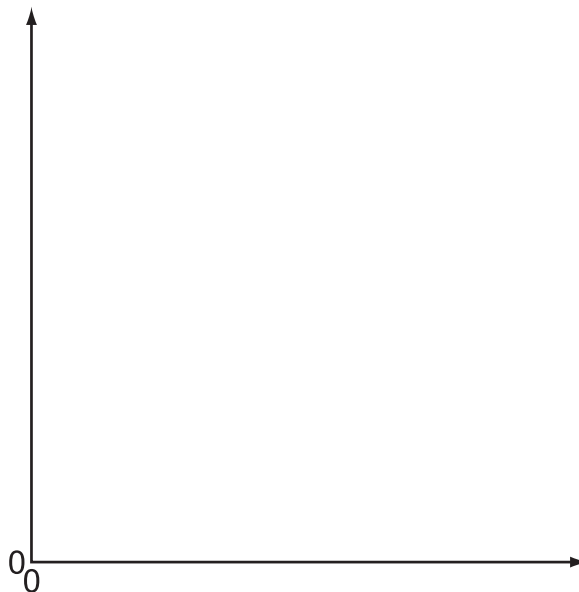

maximum 5 marks

---

**BLANK PAGE**

11. Sunita puts on a pair of special glasses as shown below. The glasses have coloured filters in them.



- (a) Sunita looks at a lamp through the green filter. The lamp gives out white light, but appears to be green. Explain how this is possible.

2 marks

---

---

---

- (b) Sunita looks at a red lamp.

- (i) What colour will the lamp appear to Sunita, if she looks at it through the red filter?

---

Explain your answer.

---

---

1 mark

- (ii) What colour will the lamp appear to Sunita, if she looks at it through the green filter?

---

Explain your answer.

---

---

maximum 5 marks

12. A headline from a newspaper is shown below.



Some countries claim that acid rain caused by power stations in Britain damages their forests.  
Others argue that coal-burning power stations produce cheap electricity and that plants can stand some level of acid rain.

Imagine you are planning a laboratory investigation of the claim:

***'plants can stand some level of acid rain'.***

Assume you have access to whatever laboratory equipment you need, including:

- seeds
- acid
- seed trays
- soil

Plan a laboratory investigation to test the claim that **'plants can stand some level of acid rain'**.

- (a) Name a factor you would need to vary in your investigation.  
(This is the independent variable.)

1 mark

---

- (b) (i) What factor would you examine to see the effect?  
(This is the dependent variable.)

1 mark

---

---

- (ii) How could you measure this dependent variable?

1 mark

---

- (c) Suggest **one** factor you would control to ensure that your investigation is fair.

1 mark

---

maximum 4 marks



---

13. (a) Magnesium chloride is formed when magnesium reacts with an acid.

- (i) Complete the word equation for the reaction between magnesium and this acid.

magnesium + \_\_\_\_\_  $\rightarrow$  magnesium + \_\_\_\_\_  
chloride

2 marks

- (ii) Suggest why magnesium chloride can be made by mixing magnesium with this acid but copper chloride **cannot** be made by mixing copper with this acid.

1 mark

---

---

- (b) Copper sulphate is made by adding copper oxide to a different acid. Give the name of the acid which is used.

1 mark

---

- (c) In the table below, write the name of the compound represented by each formula.

2 marks

formula	name
$\text{CuSO}_4$	
$\text{MgCl}_2$	

maximum 6 marks

- 
14. The drawing shows a bluebell plant. The plant grows from an underground stem called a bulb.  
Each year new leaves and flowers grow from the bulb.

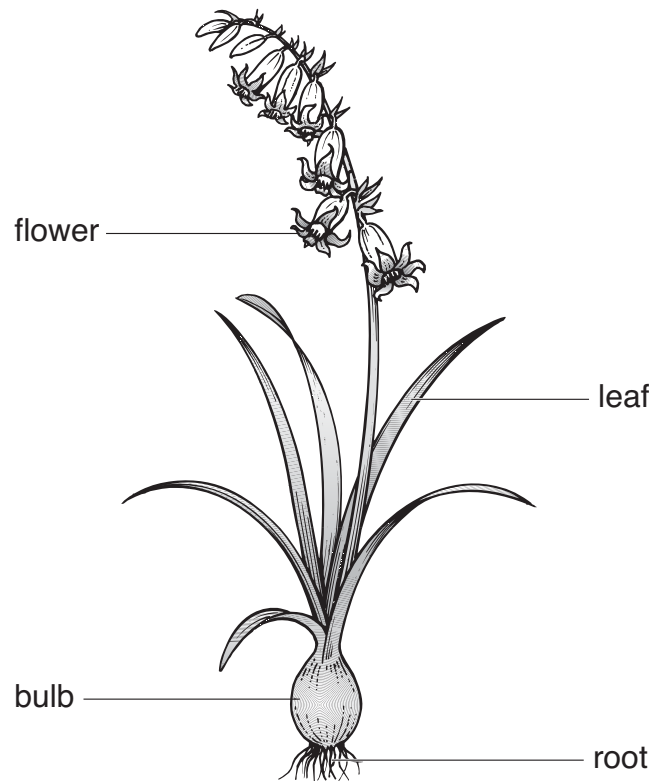

- (a) Describe the process by which glucose is made in the leaves.

3 marks

---

---

---

---

---

- (b) Many plants make starch from glucose.  
What group of nutrients do both glucose and starch belong to?

1 mark

---

- 
- (c) In the sixteenth century bluebell bulbs were dug up to obtain a starch-like substance that was used to make collars stiff.



- (i) Digging up bluebell bulbs has caused a decrease in the number of bluebells growing in Britain.  
It is now against the law to dig up bluebells.

Suggest **one** other environmental reason why the number of bluebell plants has decreased in Britain.

1 mark

---

---

- (ii) Every 10 years the trees and bushes in some bluebell woods are cut down to ground level.

What effect does this have on the number of bluebells in the woods?  
Explain your answer.

1 mark

---

---

maximum 6 marks



15. A group of pupils recorded some different characteristics of pupils in their class.



The table below shows their results.

name	gender	height, in cm	mass, in kg	hand span, in cm	arm span, in cm	eye colour
Julie	girl	152	48	17.2	160	blue
Laura	girl	157	54	15.0	141	green
Aftab	boy	159	49	18.4	172	brown
Jenna	girl	144	46	17.4	161	hazel
Barry	boy	148	49	17.4	162	blue
Oliver	boy	172	57	21.5	204	brown
Safina	girl	155	48	16.8	158	brown
Maria	girl	154	50	17.9	166	green
Amanat	girl	162	46	16.2	150	brown
Thomas	boy	157	49	19.9	186	blue

(a) Oliver concluded that boys do **not** have green eyes.

Explain why his conclusion is **not** justified.

1 mark

\_\_\_\_\_

(b) Name **two continuous** variables in their table.

1. \_\_\_\_\_

2. \_\_\_\_\_

1 mark

(c) Look at the scatter graphs below.

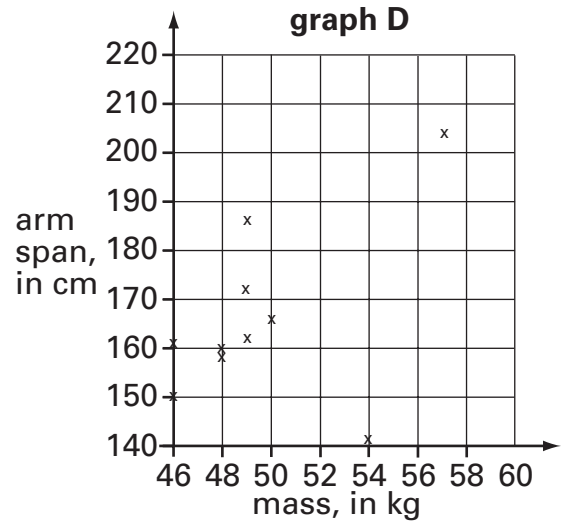
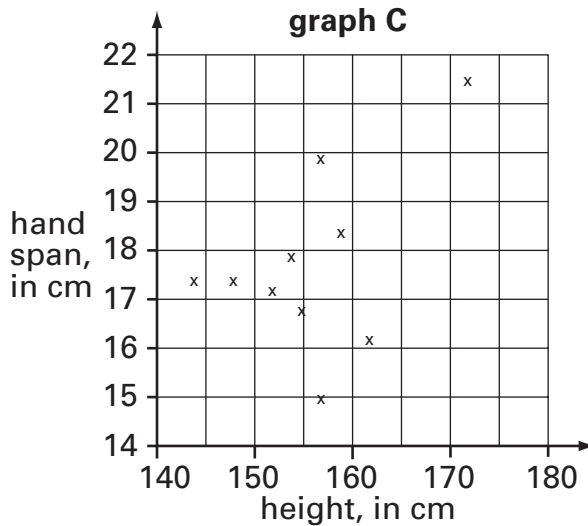
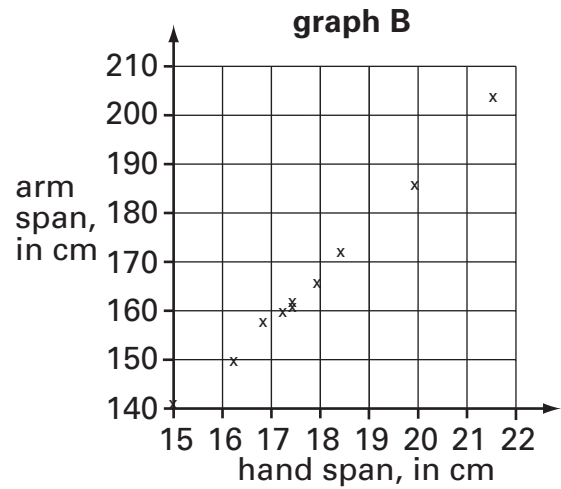
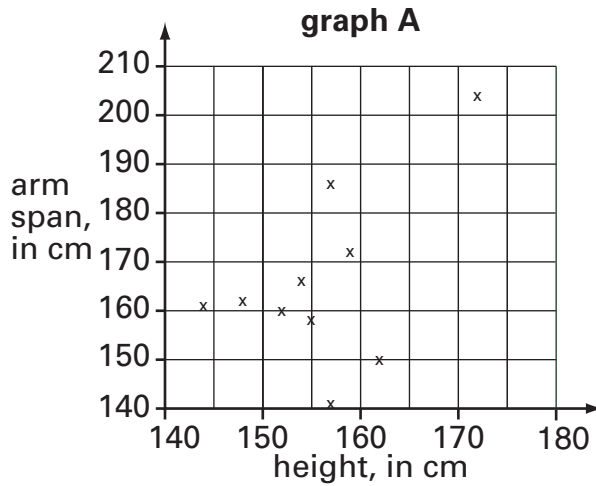

Use the data in the scatter graphs to show whether each of the conclusions below is **true**, **false** or you **cannot tell**.

2 marks

**conclusions**

**true or false or cannot tell**

Graph C shows that the shortest pupil has the smallest hand span.

\_\_\_\_\_

Graph B shows the strongest correlation between two variables.

\_\_\_\_\_

Graph A looks similar to graph C because of the high correlation of arm span to hand span.

\_\_\_\_\_

Boys are generally taller than girls.

\_\_\_\_\_

maximum 4 marks

---

**END OF TEST**



